

Retroreflective sensor

VL18-54-M-LAS/40a/118/128

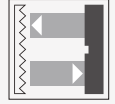

- M18 threaded housing made of brass, nickel plated
- Visible red light, pulsed LASER light
- Array control panel with highly visible LED display
- Flashing power on LED in case of short-circuit
- Multiple device installation possible, no mutual interference (no cross-talk)
- Not sensitive to ambient light, even with switched energy saving lamps
- Protection class II

Retroreflective sensor with polarization filter



Dimensions

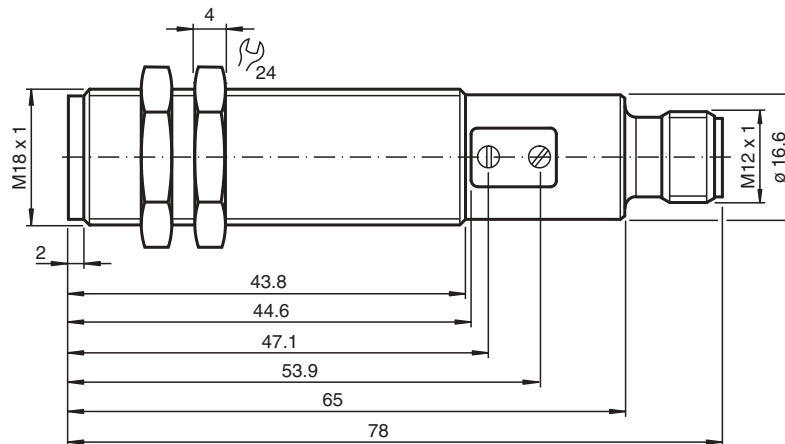

Release date: 2022-08-08 Date of issue: 2022-08-08 Filename: 800182_eng.pdf

Refer to "General Notes Relating to Pepperl+Fuchs Product Information".

Pepperl+Fuchs Group
www.pepperl-fuchs.com

USA: +1 330 486 0001
fa-info@us.pepperl-fuchs.com

Germany: +49 621 776 1111
fa-info@de.pepperl-fuchs.com

Singapore: +65 6779 9091
fa-info@sg.pepperl-fuchs.com

PEPPERL+FUCHS

Technical Data

General specifications		
Effective detection range		0 ... 18 m
Reflector distance		0.06 ... 18 m
Threshold detection range		20 m
Reference target		H85 reflector
Light source		laser diode
Light type		modulated visible red light
Polarization filter		yes
Laser nominal ratings		
Note		LASER LIGHT , DO NOT STARE INTO BEAM
Laser class		1
Wave length		655 nm
Beam divergence		7.5 mrad
Pulse length		4 μ s
Repetition rate		11.91 kHz
max. pulse energy		2.25 nJ
Diameter of the light spot		150 mm x 100 mm at a distance of 12 m
Opening angle		1 °
Optical face		frontal
Ambient light limit		30000 Lux
Hysteresis	H	< 15 %
Functional safety related parameters		
MTTF _d		700 a
Mission Time (T _M)		20 a
Diagnostic Coverage (DC)		0 %
Indicators/operating means		
Operation indicator		LED green, flashes in case of short-circuit
Function indicator		LED yellow, light with free light beam , flashes when falling short of the stability control , OFF when light beam is interrupted
Control elements		Sensitivity adjuster, light/dark switch
Electrical specifications		
Operating voltage	U _B	10 ... 30 V DC , class 2
No-load supply current	I ₀	< 20 mA
Protection class		II , rated voltage \leq 50 V AC with pollution degree 1-2 according to IEC 60664-1
Output		
Switching type		light/dark on, switchable
Signal output		Push-pull (4 in 1) output short-circuit protected overvoltage protected
Switching voltage		max. 30 V DC
Switching current		max. 200 mA
Voltage drop	U _d	\leq 2.5 V DC
Switching frequency	f	500 Hz
Response time		1 ms
Conformity		
Product standard		EN 60947-5-2
Compliance with standards and directives		
Standard conformity		
Laser class		IEC 60825-1:2007 Complies with 21 CFR 1040.10 and 1040.11 except for deviations pursuant to Laser Notice No. 50, dated June 24, 2007
Approvals and certificates		
EAC conformity		TR CU 020/2011
UL approval		cULus Listed, Type 1 enclosure
CCC approval		CCC approval / marking not required for products rated \leq 36 V
Ambient conditions		
Ambient temperature		-25 ... 55 °C (-13 ... 131 °F)

Release date: 2022-08-08 Date of issue: 2022-08-08 Filename: 800182_eng.pdf

Refer to "General Notes Relating to Pepperl+Fuchs Product Information".

Pepperl+Fuchs Group
www.pepperl-fuchs.com

USA: +1 330 486 0001
fa-info@us.pepperl-fuchs.com

Germany: +49 621 776 1111
fa-info@de.pepperl-fuchs.com

Singapore: +65 6779 9091
fa-info@sg.pepperl-fuchs.com

 PEPPERL+FUCHS

Technical Data

Storage temperature	-30 ... 70 °C (-22 ... 158 °F)
Mechanical specifications	
Degree of protection	IP67
Connection	4-pin, M12 x 1 connector
Material	
Housing	brass, nickel-plated
Optical face	PMMA
Mass	60 g

Connection Assignment

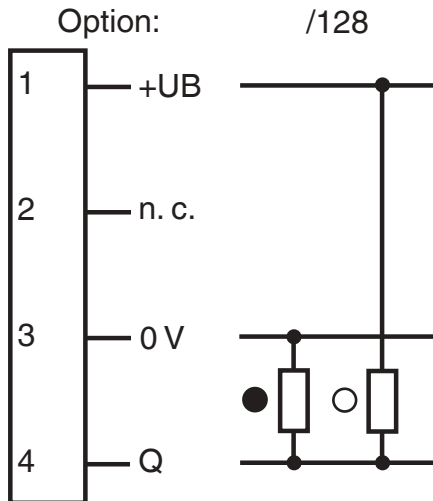

○ = Light on
● = Dark on

Connection Assignment

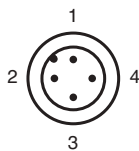

Wire colors in accordance with EN 60947-5-2

1	BN	(brown)
2	WH	(white)
3	BU	(blue)
4	BK	(black)

Release date: 2022-08-08 Date of issue: 2022-08-08 Filename: 800182_eng.pdf

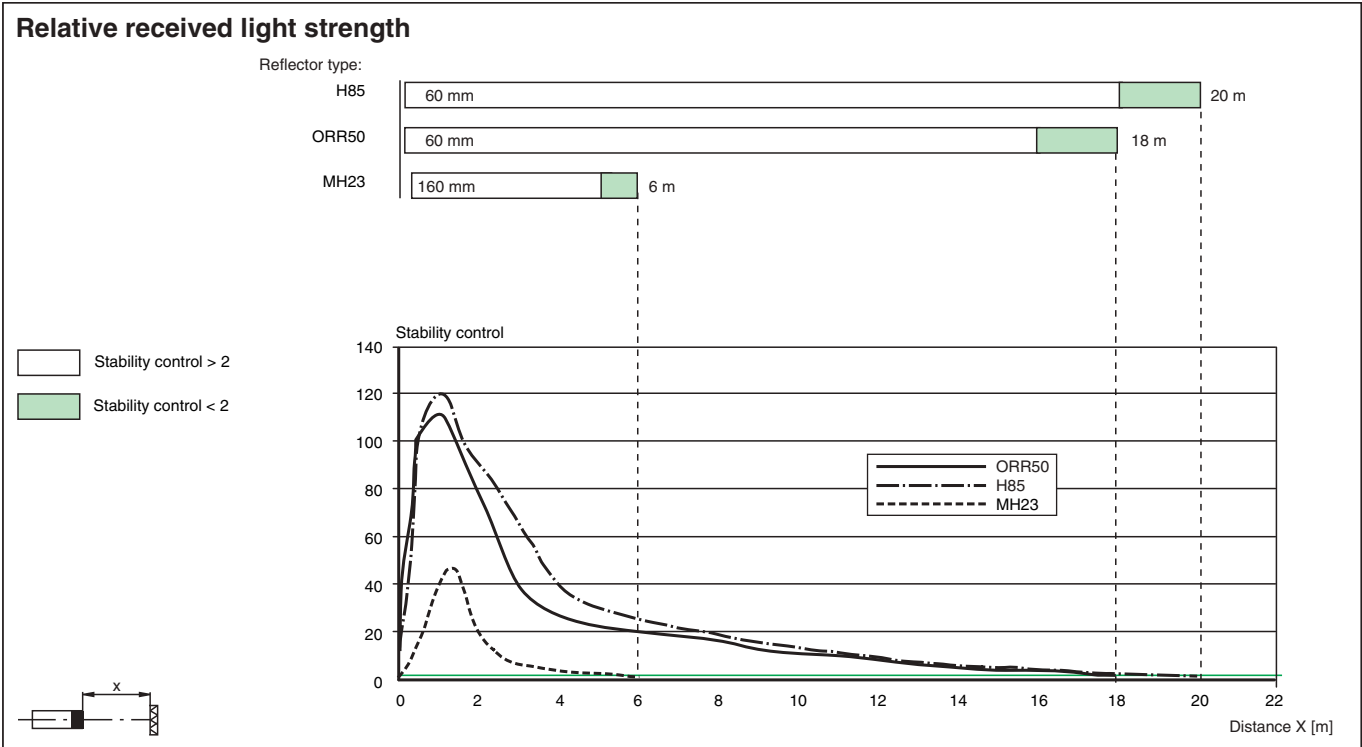
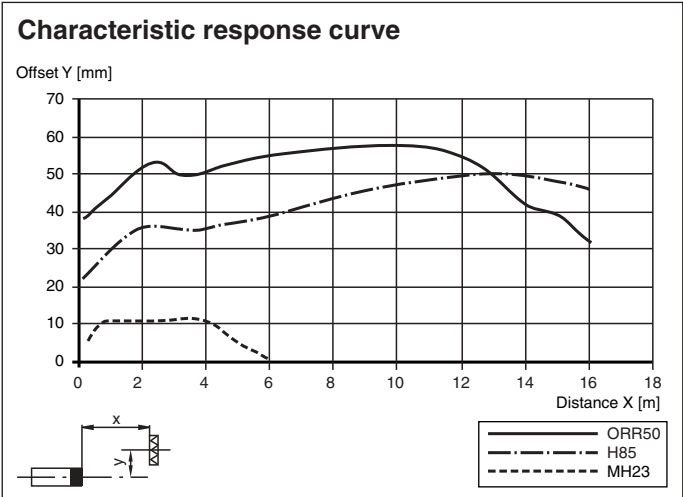

Characteristic Curve



Safety Information





Laser Class 1 Information
 The irradiation can lead to irritation especially in a dark environment. Do not point at people!
 Maintenance and repairs should only be carried out by authorized service personnel!
 Attach the device so that the warning is clearly visible and readable.
 The warning accompanies the device and should be attached in immediate proximity to the device.
 Caution – Use of controls or adjustments or performance of procedures other than those specified herein may result in hazardous radiation exposure.

Accessories

	OMH-VL18	Mounting Bracket with swivel nut
	BF 18	Mounting flange, 18 mm
	BF 18-F	Plastic mounting adapter, 18 mm

Release date: 2022-08-08 Date of issue: 2022-08-08 Filename: 800182_eng.pdf

Accessories

	BF 5-30	Universal mounting bracket for cylindrical sensors with a diameter of 5 ... 30 mm
	REF-MH23	Reflector with Micro-structure, rectangular 23 mm x 13.8 mm, diagonal mounting hole
	REF-H100	Reflector, rectangular 122 mm x 99.35 mm, mounting holes
	REF-H85-2	Reflector, rectangular 84.5 mm x 84.5 mm, mounting holes
	REF-H50	Reflector, rectangular 51 mm x 61 mm, mounting holes, fixing strap