

# Connection cable, shielded

## V1-G-10M-PUR-ABG-V1-W



- Degree of protection IP68 / IP69
- Halogen-free
- Shield connected to screw connection
- Specific design protects against loosening and inaccurate installation

Cordset M12 socket straight to M12 plug angled A-coded, 4-pin, PUR cable grey, shielded



### Dimensions

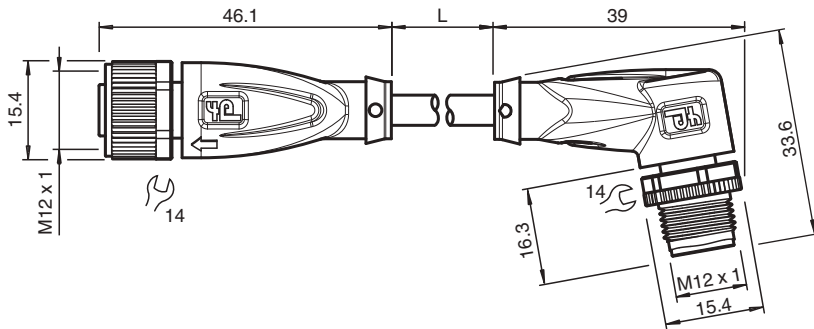

### Technical Data

#### General specifications

|                   |  |  |                  |
|-------------------|--|--|------------------|
| Connector 1       |  |  |                  |
| Connection        |  |  | socket           |
| Construction type |  |  | M12              |
| Style             |  |  | straight         |
| Locking           |  |  | screw connection |
| Number of pins    |  |  | 4                |
| Coding            |  |  | A-coded          |
| Connector 2       |  |  |                  |
| Connection        |  |  | plug             |
| Construction type |  |  | M12              |
| Style             |  |  | angled           |
| Locking           |  |  | screw connection |
| Number of pins    |  |  | 4                |
| Coding            |  |  | A-coded          |

#### Electrical specifications

|                   |       |  |                  |
|-------------------|-------|--|------------------|
| Operating voltage | $U_B$ |  | max. 250 V AC/DC |
| Operating current | $I_B$ |  | max. 4 A         |

#### Conformity

|                      |  |  |                                     |
|----------------------|--|--|-------------------------------------|
| Degree of protection |  |  | EN 60529                            |
| Plug connection      |  |  | connector M12 x 1 : IEC 61076-2-101 |

Release date: 2023-07-13 Date of issue: 2023-07-13 Filename: 127064\_eng.pdf

Refer to "General Notes Relating to Pepperl+Fuchs Product Information".

Pepperl+Fuchs Group  
www.pepperl-fuchs.com

USA: +1 330 486 0001  
fa-info@us.pepperl-fuchs.com

Germany: +49 621 776 1111  
fa-info@de.pepperl-fuchs.com

Singapore: +65 6779 9091  
fa-info@sg.pepperl-fuchs.com

PEPPERL+FUCHS

## Technical Data





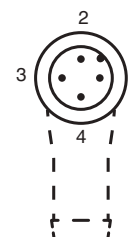
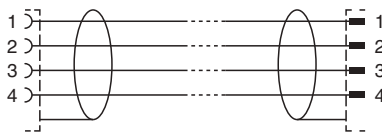
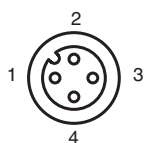

|                                  |                                      |   |
|----------------------------------|--------------------------------------|---|
| Halogen-free                     | DIN VDE 0472-815<br>DIN EN 50267-2-1 |   |
| <b>Ambient conditions</b>        |                                      |   |
| Ambient temperature              |                                      |   |
| Plug connector                   |                                      | -40 ... 90 °C (-40 ... 194 °F)                                  |
| Cable, fixed                     |                                      | -40 ... 80 °C (-40 ... 176 °F)                                  |
| Cable, flexing                   |                                      | -25 ... 80 °C (-13 ... 176 °F)                                  |
| Pollution degree                 |                                      | 3   |
| <b>Mechanical specifications</b> |                                      |   |
| Plug connector                   |                                      |   |
| Tightening torque                |                                      | 0.6 Nm  |
| Loosening protection             |                                      | available   |
| Tool installation                |                                      | straight knurling and hexagon nut SW = 14 mm                    |
| Mating cycles                    |                                      | min. 100  |
| Shielding                        |                                      | shield connected to screw connection                            |
| Degree of protection             |                                      | IP68 / IP69   |
| Cable                            |                                      |   |
| Sheath diameter                  |                                      | 4.8 mm  |
| Bending radius                   |                                      | > 10 x cable diameter, moving<br>> 5 x cable diameter, fixed    |
| Sheath stripping force           |                                      | max. 100 N / 300 mm   |
| Sheath color                     |                                      | grey (similar to RAL 7001)                                      |
| Number of cores                  |                                      | 4   |
| Core cross section               |                                      | 0.34 mm <sup>2</sup>  |
| Cores color                      |                                      | Core 1: brown<br>Core 2: white<br>Core 3: blue<br>Core 4: black |
| Core construction                |                                      | 19 x 0.15 mm Ø  |
| Shield                           |                                      | tinned copper braiding, 85 % coverage                           |
| Length                           | L                                    | 10 m  |
| Cable code                       |                                      | Li 9Y 11YM 4 x 0.34   |
| <b>Material</b>                  |                                      |   |
| Halogen-free                     |                                      | yes   |
| Plug connector                   |                                      |   |
| Screw connection                 |                                      | Zinc diecast, nickel-plated                                     |
| Body                             |                                      | TPU, black  |
| Seal                             |                                      | FKM   |
| Contact surface                  |                                      | gold plated (Au)  |
| Flammability                     |                                      | V-2   |
| Cable                            |                                      |   |
| Sheathing                        |                                      | PUR based on polyether  |
| Core insulation                  |                                      | PP  |
| Chemical resistance              |                                      | good  |

## Connection



Release date: 2023-07-13 Date of issue: 2023-07-13 Filename: 127064\_eng.pdf

**Accessories**

|   |                              |  |
|---|------------------------------|--|
|  | <b>MH V1-SCREWDRIVER</b>     | Torque screwdriver (0.6 Nm)                      |
|  | <b>MH V1-BIT M12</b>         | plug-in cap M12                                  |
|  | <b>V1/V3-LABELHOLDER</b>     | Label holder                                     |
|  | <b>V1/V3-LABEL</b>           | Label plate                                      |
|  | <b>MH V1-Holder</b>          | Modular universal holder for M12 connectors      |
|  | <b>V1-CLIP</b>               | Unlocking protector for M12 connector            |
|  | <b>V1-MARKING-RING-COLOR</b> | Marking rings for M12 connectors, various colors |

Release date: 2023-07-13 Date of issue: 2023-07-13 Filename: 127064\_eng.pdf

Refer to "General Notes Relating to Pepperl+Fuchs Product Information".

Pepperl+Fuchs Group  
www.pepperl-fuchs.com

USA: +1 330 486 0001  
fa-info@us.pepperl-fuchs.com

Germany: +49 621 776 1111  
fa-info@de.pepperl-fuchs.com

Singapore: +65 6779 9091  
fa-info@sg.pepperl-fuchs.com