

Background suppression sensor

MLV12-8-H-250-RT/47/65b/92

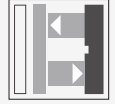

- Reliable detection of all surfaces, independent of color and structure
- Minimal black-white difference
- Ultra bright LEDs for power on and switching state
- Flashing power on LED in case of short-circuit
- Not sensitive to ambient light, even with switched energy saving lamps
- Multiple device installation possible, no mutual interference (no cross-talk)
- Protection class II

Triangulation sensor with background suppression in a widely used standard housing, red light, 250 mm detection range, electrically adjustable, light/dark on, two PNP outputs, M12 plug



Dimensions

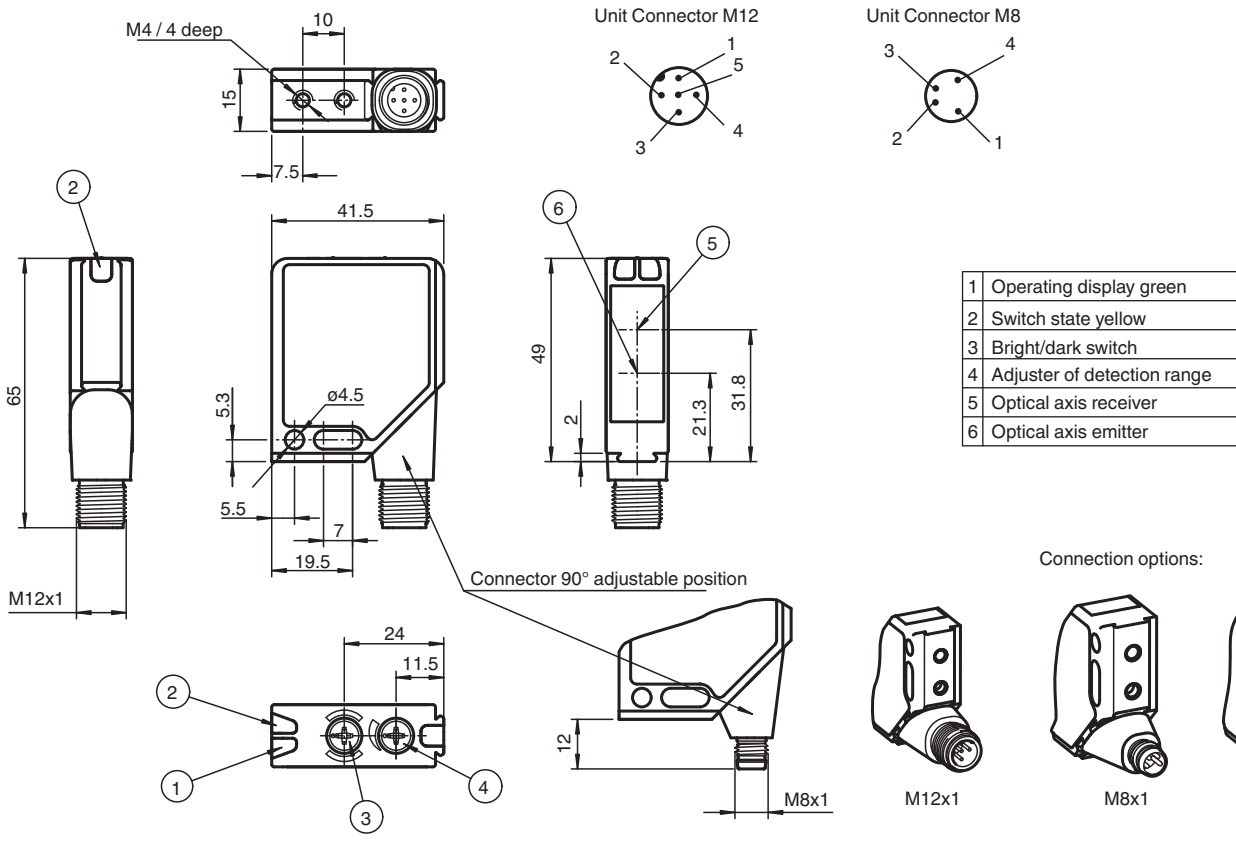

Release date: 2023-04-04 Date of issue: 2023-04-04 Filename: 117834_eng.pdf

Refer to "General Notes Relating to Pepperl+Fuchs Product Information".

Pepperl+Fuchs Group
www.pepperl-fuchs.com

USA: +1 330 486 0001
fa-info@us.pepperl-fuchs.com

Germany: +49 621 776 1111
fa-info@de.pepperl-fuchs.com

Singapore: +65 6779 9091
fa-info@sg.pepperl-fuchs.com

PEPPERL+FUCHS

Technical Data

General specifications		
Detection range		20 ... 250 mm , adjustable
Detection range min.		20 ... 50 mm
Detection range max.		20 ... 250 mm
Adjustment range		50 ... 250 mm
Light source		LED
Light type		modulated visible red light , 660 nm
Black-white difference (6 %/90 %)		10 % at 250 mm
Diameter of the light spot		8 mm at Tw 250 mm
Opening angle		1.5 °
Ambient light limit		
Continuous light		30000 Lux
Modulated light		5000 Lux
Functional safety related parameters		
MTTF _d		650 a
Mission Time (T _M)		20 a
Diagnostic Coverage (DC)		0 %
Indicators/operating means		
Operation indicator		LED green, flashes in case of short-circuit
Function indicator		2 LEDs yellow ON: object inside the scanning range OFF: object outside the scanning range
Control elements		potentiometer for light/dark, detection range adjustment
Electrical specifications		
Operating voltage	U _B	10 ... 30 V DC
Ripple		max. 10 %
No-load supply current	I ₀	≤ 55 mA
Output		
Switching type		light/dark on switchable
Signal output		2 PNP outputs, complementary, short-circuit protected, reverse polarity protected, open collector
Switching voltage		max. 30 V DC
Switching current		max. 0.2 A
Voltage drop	U _d	≤ 2.5 V DC
Switching frequency	f	1000 Hz
Response time		0.5 ms
Conformity		
Product standard		EN 60947-5-2
Compliance with standards and directives		
Standard conformity		
Shock and impact resistance		IEC / EN 60068. half-sine, 40 g in each X, Y and Z directions
Vibration resistance		IEC / EN 60068-2-6. Sinus. 10 -150 Hz, 5 g in each X, Y and Z directions
Approvals and certificates		
Protection class		II, rated voltage ≤ 300 V AC with pollution degree 1-2 according to IEC 60664-1
UL approval		cULus
CCC approval		CCC approval / marking not required for products rated ≤36 V
Ambient conditions		
Ambient temperature		-40 ... 60 °C (-40 ... 140 °F)
Storage temperature		-40 ... 75 °C (-40 ... 167 °F)
Mechanical specifications		
Housing width		41.5 mm
Housing height		49 mm
Housing depth		15 mm
Degree of protection		IP67

Release date: 2023-04-04 Date of issue: 2023-04-04 Filename: 117834_eng.pdf

Refer to "General Notes Relating to Pepperl+Fuchs Product Information".

Pepperl+Fuchs Group
www.pepperl-fuchs.com

USA: +1 330 486 0001
fa-info@us.pepperl-fuchs.com

Germany: +49 621 776 1111
fa-info@de.pepperl-fuchs.com

Singapore: +65 6779 9091
fa-info@sg.pepperl-fuchs.com

 PEPPERL+FUCHS

Technical Data

Connection	4-pin, M12 metal connector, 90° rotatable
Material	
Housing	Frame: nickel plated, die cast zinc, Laterals: glass-fiber reinforced plastic PC
Optical face	Plastic pane
Mass	60 g

Connection

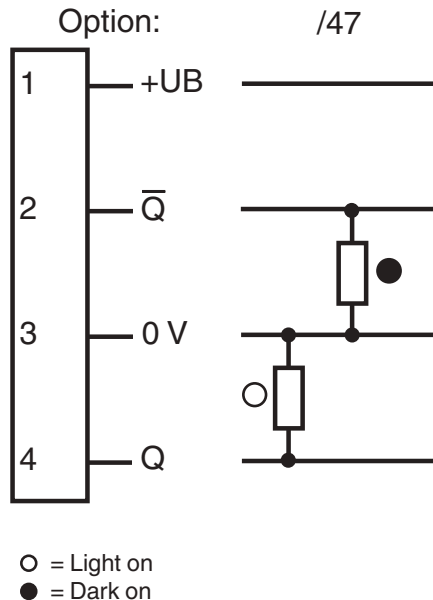

Connection Assignment

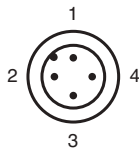





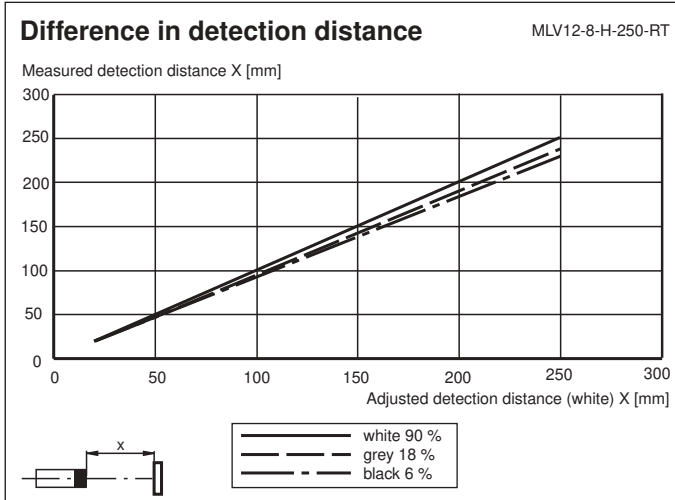
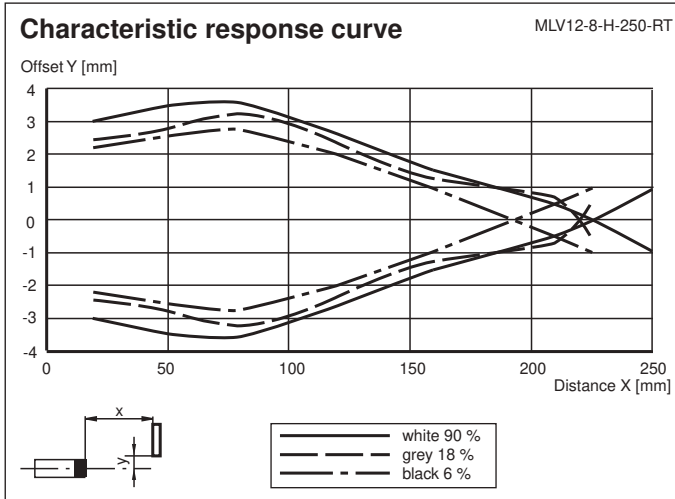

Wire colors in accordance with EN 60947-5-2

1	BN	(brown)
2	WH	(white)
3	BU	(blue)
4	BK	(black)



Accessories

	OMH-MLV12-HWG	Mounting bracket for series MLV12 sensors
	OMH-MLV12-HWK	Mounting bracket for series MLV12 sensors
	OMH-K01	dove tail mounting clamp
	OMH-K02	dove tail mounting clamp
	OMH-K03	dove tail mounting clamp
	OMH-06	Mounting aid for round steel \varnothing 12 mm or sheet 1.5 mm ... 3 mm

Release date: 2023-04-04 Date of issue: 2023-04-04 Filename: 117834_eng.pdf