



Allen-Bradley

160 SSC™ Variable Speed Drive (Series C)

0.37–4.0 kW (0.5–5 HP)

FRN 7.03

FRN 7.04

FRN 7.05

FRN 7.06

User Manual

**Rockwell
Automation**

Important User Information

Solid-State equipment has operational characteristics differing from those of electromechanical equipment. “*Safety Guidelines for the Application, Installation and Maintenance of Solid-State Controls*” (Publication SGI-1.1) describes some important differences between solid-state equipment and hard-wired electromechanical devices. Because of this difference, and also because of the wide variety of uses for solid-state equipment, all persons responsible for applying this equipment must satisfy themselves that each intended application of this equipment is acceptable.

In no event will Rockwell Automation be responsible or liable for indirect or consequential damages resulting from the use or application of this equipment.

The examples and diagrams in this manual are included solely for illustrative purposes. Because of the many variables and requirements associated with any particular installation, Rockwell Automation cannot assume responsibility or liability for actual use based on the examples and diagrams.

No patent liability is assumed by Rockwell Automation with respect to use of information, circuits, equipment, or software described in this manual.

Reproduction of the contents of this manual, in whole or in part, without written permission of Rockwell Automation is prohibited.

Throughout this manual we use notes to make you aware of safety considerations:



ATTENTION: Identifies information about practices or circumstances that can lead to personal injury or death, property damage or economic loss.

Attention statements help you to:

- identify a hazard
- avoid a hazard
- recognize the consequences

Important: Identifies information that is especially important for successful application and understanding of the product.



Shock Hazard labels located on or inside the drive indicate that dangerous voltage may be present.

SSC is a trademark of Rockwell Automation, Inc.

Series C Summary of Changes

- **New Horsepower Ratings**
4 kW (5 HP), 230V and 460V ratings have been added to the Bulletin 160 family.
- **Increased Transient Protection**
Standard input voltage transient protection has been increased to 6 kV and contained in the drive itself. The optional MOV module is no longer required.
- **Improved Ground Fault Protection**
The Bulletin 160 detects phase-to-phase and phase-to-ground faults both at start-up and while running.
- **Reduced 2.2 kW (3 HP) Footprint**
2.2 kW (3 HP), 230V and 460V width has been reduced by more than 45%.
- **One Piece, 1.5 kW (2 HP) 230V Single Phase Unit**
The external capacitor module has been integrated into the 1.5 kW (2 HP), 230V single phase unit. The overall width of the unit is reduced, however, the height, depth, and mounting hole pattern has changed.
- **Improved Start/Stop Overlap Timing**
The STOP command can be removed up to 20 msec after a START command and the drive will still recognize the START command. This allows the drive to respond to a START command occurring concurrently with or slightly after a STOP command is removed.
- **Additional Fault History**
P17, P18, and P19 - [Fault Buffer 0, 1 and 2] have been added to record the last three faults for diagnostic purposes.
- **Analog Model with Preset Speed Capability**
Analog Signal Follower models have an additional input mode. With P46 - [Input Mode] setting 8, four preset speeds are available.
- **External Frequency Selection**
P46 - [Input Mode] has an additional setting (setting 7) which allows for the frequency source to be switched from the control terminal block (TB3) to the P58 - [Internal Frequency] setting.
- **New Output Configuration Setting**
P47 - [Output Configure] has a new setting. When setting 10 is selected, the output will be active when the Power Factor Angle is above the P48 - [Output Threshold] setting.
- **Additional Compensation Mode**
P78 - [Compensation] has an additional mode that corrects for slow responding systems which can cause current regulator oscillations.
- **Software Current Trip**
P79 - [Software Current Trip] provides an adjustable software current trip with a one second time delay.
- **Adjustable Stall Fault Time**
The time that the drive must be in a stall condition before causing a stall fault is selectable via P80 - [Stall Fault Time].
- **PI Control**
Process control is now intergrated in the drive through a PI regulator. Users of Firmware Version FRN 7.05 and earlier activate this feature with P46 - [Input Mode] setting 9. Users of Firmware Version FRN 7.06 can activate this feature with P46 - [Input Mode] settings 0 through 7 and 9. PI control is adjusted through parameters P81 - [PI Proportional Gain], P82 - [PI Integrated Gain], P83 - [PI Process Reference], and P84 - [PI Dead Band].
- **Fault Auto Clear**
Over voltage, Under voltage, and Over temperature faults are automatically cleared when the fault condition is removed.
- **RS-232 Serial Communication**
An RS-232 serial communication module using a DF1 protocol is now available. See 160-RS1 User Manual for additional information.
- **Ground Screw Location**
Grounding screws are now located on the power connection terminal blocks for easier wiring.

Series C Application/Installation Considerations

Keep the following in mind if you are replacing a Bulletin 160 Series A or B drive with a Series C unit.

Mounting Dimensions

- Width has increased by 8 mm for all ratings through 1.5 kW (2 HP).
Note: If proper spacing recommendations were followed for Series A and B drives, the increased width should not effect the panel layout because Series C drives of this rating do not require spacing between units.
- Width has decreased by 50 mm for the 2.2 kW (3 HP) rating.
- Depth has increased by 25 mm for all ratings through 2.2 kW (3 HP).
Note: The drive utilizes the same DIN base and mounting hole pattern for all ratings through 2.2 kW (3 HP).

External Braking

- The internal brake transistor is *not* available on 0.37 kW (1/2 HP) and 0.55 kW (3/4 HP) units. If external braking is required, a 0.75 kW (1 HP) drive must be used.

DeviceNet

- DeviceNet modules (Catalog No.160-DN1) with Firmware Version FRN 2.0 or earlier are not compatible with the Bulletin 160 Series C drives. Series C drives must use DeviceNet modules (Catalog No. 160-DN2). The 160-DN2 module is also compatible with Series A and B drives with the exception of the Series A Preset Speed model with Firmware Version FRN 4.04.

24V DC Interface

- Bulletin 160 Series C drives must use a Series B, or later, 24V DC Interface module. See Appendix B for catalog numbers.

Terminal Block Wiring

- The ground terminal is now located on the power terminal block. Refer to Figure 2.2 on page 2-3 to avoid incorrect wiring.

Incorrect Motor Rotation

- The output phasing of Series C drives is different than the output phasing of Series A and B drives. Replacing a Series A or B drive with a Series C drive using the same U, V and W (T1, T2 and T3) connections will reverse the motor rotation. To assure the same direction of rotation, switch any 2 of the 3 output wires connected to U, V or W (T1, T2 or T3) from the motor.

Example:

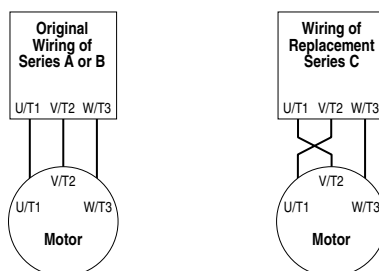

Getting Started

Important Precautions	1-1
Receiving Your New Drive	1-2
Unpacking	1-2
Inspecting	1-2
Identifying Your Drive	1-2
Catalog Number	1-2
Nameplate	1-3
Conventions Used In This Manual	1-3
Standard Drive Features	1-4
Optional Drive Features	1-5

Installation and Wiring

Storage and Operation Conditions	2-1
CE Compliance	2-1
Installation	2-1
Clearances	2-1
Debris Label	2-1
Power Wiring	2-2
Precautions	2-2
Terminal Blocks	2-2
Terminal Block Wiring	2-3
Specifications	2-3
Motor Branch Circuit Analysis	2-4
Branch Circuit Protective Devices	2-5
Input Power Conditioning	2-6
Motor Cable Types	2-6
Long Motor Cable Effects	2-7
Control Wiring	2-9
Requirements	2-9
Specifications	2-9
Important Precautions	2-9
Control Wiring Considerations	2-10
Control Methods and Selection Guide	2-11
Configurable Relay Output Contacts (P47 Settings)	2-18
Frequency Source Wiring	2-18
Analog Signal Follower Model	2-18
Preset Speed Model	2-20
Analog and Preset Models	2-20
What To Do Next	2-20

Program Keypad Module

Features	3-1
Display Mode	3-1
Program Mode	3-1
Key Functions	3-2
Module Removal and Installation	3-3
Removal	3-3
Installation	3-4

Start-Up

Start-Up Procedures	4-1
---------------------------	-----

Parameters and Programming

Overview of Parameters	5-1
Important Reset Actions	5-2
Programming Example	5-2
Display Group Parameters (Read Only)	5-3
Program Group Parameters	5-5
PI Control Setup and Activation	5-17
Wire For PI Control	5-17
Program for PI Control	5-17
Tune the PI Loop	5-18
Common Problems with PI Control	5-19

Troubleshooting

Fault Information	6-1
How to Clear a Fault	6-1

Specifications

A-1

Accessories and Dimensions

B-1

Accessory Dimensions	B-2
----------------------------	-----

Drive Dimensions	B-6
------------------------	-----

CE Conformity

CE Compliance	C-1
Essential Requirements for a Conforming EMC Installation	C-1
General Instructions for an EMC Compliant Installation	C-2
Shielded Enclosure	C-2
Cable Clamps	C-3
Motor Cable	C-3
Control Cable	C-4
Low Voltage Directive 73/23/EEC Compliance	C-5

Getting Started

Important Precautions

In addition to the precautions listed throughout this manual, you must read and understand the following statements which identify hazards associated with AC drives.



ATTENTION: The drive contains high voltage capacitors which take time to discharge after removal of mains supply. Before working on drive, ensure isolation of mains supply from line inputs [R, S, T (L1, L2, L3)]. Wait three minutes for capacitors to discharge to safe voltage levels. Failure to do so may result in personal injury or death.

Darkened display LEDs is not an indication that capacitors have discharged to safe voltage levels.



ATTENTION: Only personnel familiar with the drive and associated machinery should plan or implement the installation, start-up, and subsequent maintenance of the system. Failure to comply may result in personal injury and/or equipment damage.



ATTENTION: The surface temperatures of the drive may become hot, which may cause injury.



ATTENTION: This drive contains ESD (Electrostatic Discharge) sensitive parts and assemblies. Static control precautions are required when installing, testing, servicing or repairing this assembly. Component damage may result if ESD control procedures are not followed. If you are not familiar with static control procedures, reference Publication 8000-4.5.2, “Guarding Against Electrostatic Damage” or any other applicable ESD protection handbook.



ATTENTION: An incorrectly applied or installed drive can result in component damage or reduction in product life. Wiring or application errors such as undersizing the motor, supplying an incorrect or an inadequate AC supply, or excessive ambient temperatures may result in system malfunction.

Receiving Your New Drive

It is your responsibility to thoroughly inspect the equipment before accepting the shipment from the freight company. Check the item(s) received against your purchase order. If any items are obviously damaged, do not accept delivery until the freight agent notes the damage on the freight bill.

Unpacking

Remove all packing material, wedges, or braces from within and around the drive. Remove all packing material from the heat sink. Leave the debris label in place.

If you find any concealed damage during unpacking notify the freight agent. Also, leave the shipping container intact and have the freight agent make a visual inspection of the equipment to verify damage.

Inspecting

After unpacking, check the item(s) nameplate catalog number against your purchase order. An explanation of the catalog numbering system for the Bulletin 160 drive follows as an aid for nameplate interpretation. Refer to Figure 1.1 and Figure 1.2.

Important: Before you install and start up the drive, inspect for mechanical integrity. Look for loose parts, wires, and connections.

Identifying Your Drive

Catalog Number

The figure below describes the 160 SSC catalog numbering scheme.

Catalog Number Explanation

Figure 1.1

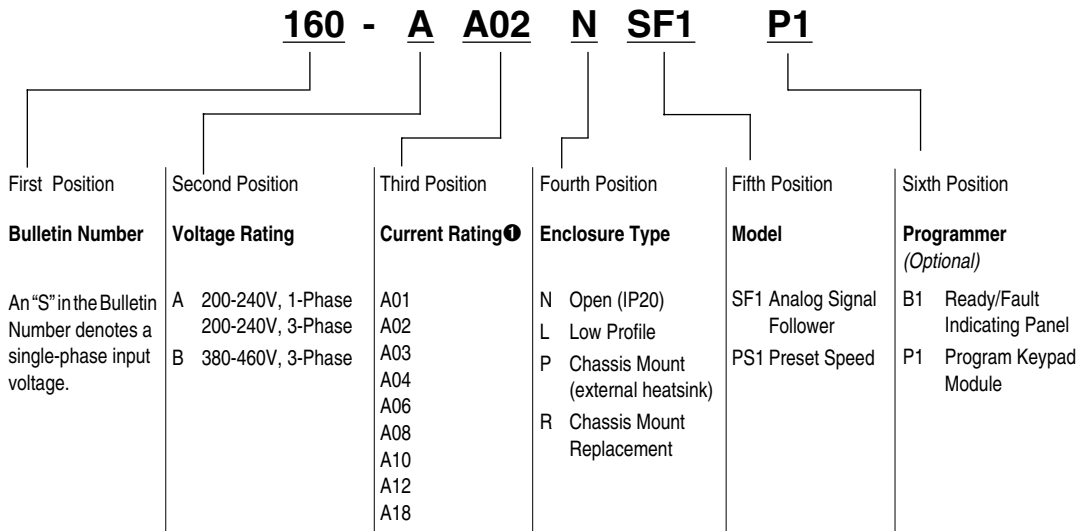

❶ Amperage ratings vary based on voltage.

Note: Rockwell Automation offers a configured drive program which allows for NEMA rated 4, 4x, or 12 enclosures.

Nameplate

The nameplate is located on the side of the drive.

Nameplate Information

Figure 1.2

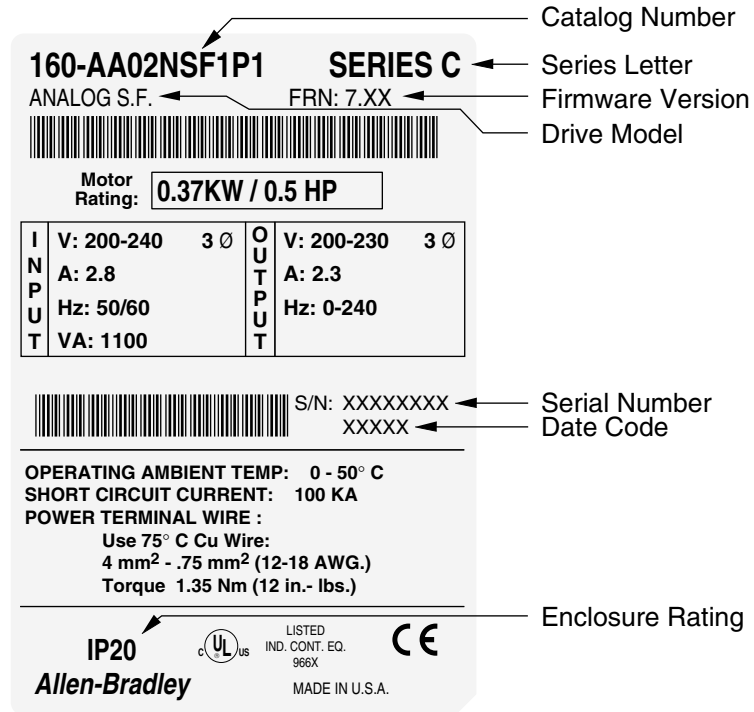

Conventions Used In This Manual

Parameter numbers and names are shown in this format: P01 - [Output Frequency]. P01 denotes the parameter number and the parameter name is enclosed in square brackets.

Standard Drive Features

The drive features identified in the figure below apply to all models.

Standard Drive Features and Mounting Orientation

Figure 1.3

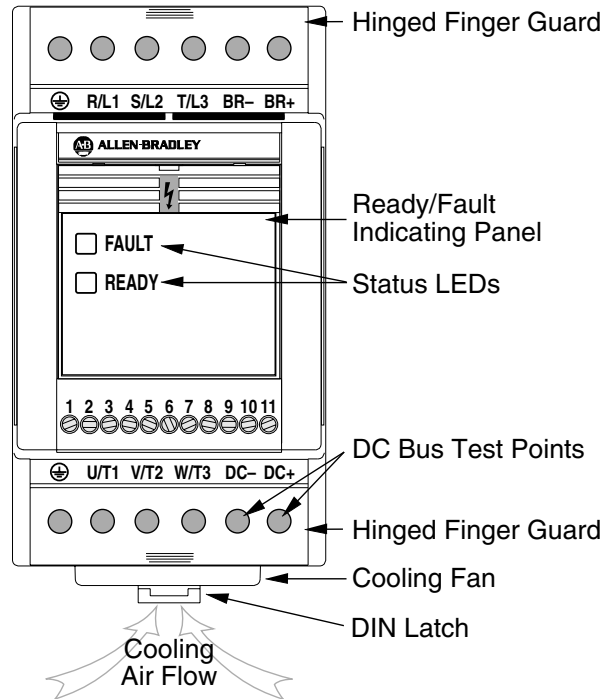

- **Hinged Finger Guard** allows easy access to line/load power terminals.
- **Ready/Fault Indicating Panel** is standard on the Bulletin 160 drive. The drive is fully functional with this panel installed. All control functions can be performed from TB3 (Control Terminal Block). Factory default settings cannot be changed with this panel.
- **Fault Indicator LED** illuminates when a drive fault condition exists. Refer to Chapter 6 for details on how to clear a fault and general troubleshooting procedures.
- **Ready Indicator LED** illuminates when the DC bus is charged and the drive is ready to run.
- **DC Bus Test Points** provide easy access for test probes when measuring DC Bus voltage.
- **Cooling Fan** provides air flow across heatsink fins to prevent overheating. Not required on .37 or .55 kW (.5 or .75 HP) ratings.
- **DIN Latch** provides an easy means for mounting the drive on standard 35 mm DIN Rail. This feature is not available with 4.0 kW (5 HP) or 1.5 kW (2 HP) single phase units.

Optional Drive Features

The drive features identified in the figure below are optional. See Appendix B for catalog numbers. (Finger guards omitted for clarity.)

Optional Drive Features

Figure 1.4

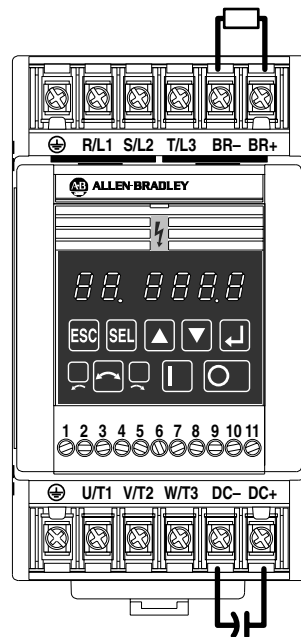

Dynamic Brake
Module

Line Filter Module

Program Keypad Module
or
DeviceNet Communication Module
or
RS-232 Communication Module
or
Remote Programming Adapter to:
Remote Keypad Module
or
CopyCat Keypad Module

24V DC Interface Module

Capacitor
Module

- **Dynamic Brake Module** option allows you to connect dynamic brake resistors. Not available on .37 or .55 kW (.5 or .75 HP) ratings.
Important: P52 - [DB Enable] must be enabled for proper operation.
- **Line Filter Module** option is available to reduce conductive emissions.
- **Program Keypad Module** option can be ordered separately and field installed, or as a factory installed option by adding "P1" to the end of the catalog number. Refer to Chapter 3, *Program Keypad Module* for a detailed explanation of functionality.
- **DeviceNet Communication Module** option allows control and monitoring of parameters via a DeviceNet network.
- **RS-232 Communication Module** option allows control and monitoring of parameters via a RS-232 network.
- **Remote Programming Adapter** option allows connection to Remote Keypad Module or Copycat Keypad Module via cable (1 to 3 meters).
- **24V DC Interface Module** option allows you to command the drive with 24V logic (sinking inputs).
- **Capacitor Module** option allows you to connect an external capacitor module. Provides extended ride through capability and improved inherent braking performance.

End of Chapter

Installation and Wiring

Storage and Operation Conditions

Follow these recommendations to prolong drive life and performance:

- Store within an ambient temperature range of -40° to $+85^{\circ}\text{C}$.
- Store within a relative humidity range of 0% to 95%, non-condensing.
- Protect the cooling fan by avoiding dust or metallic particles.
- Avoid storing or operating the drive where it could be exposed to a corrosive atmosphere.
- Protect from moisture and direct sunlight.
- Operate at an ambient temperature range of 0° to $+50^{\circ}\text{C}$.

CE Compliance

Refer to Appendix C.

Installation

Mount the drive on a flat, vertical and level surface. See Chapter 1, Figure 1.3 for mounting orientation.

Choose an installation method:

- Install with screws. Recommended screw size is listed in the table below. The appropriate drilling template for your drive is provided in Appendix B.
- Install on 35 mm DIN Rail. This mounting method is not available on 4.0 kW (5 HP) three phase or 1.5 kW (2 HP) single phase models.

Description	Metric	English
Minimum Panel Thickness (14 GA)	1.9 mm	0.0747 in.
Mounting Base Screws	m4 x 0.7	# 8-32
Mounting Torque	1.13 – 1.56 Nm	10 – 14 lb.-in.

See Appendix B for details on drive dimensions and weights.

Clearances

Maintain 12.5 mm (0.5 in.) clearance at the top, bottom, and front of all drives. Clearance requirements between units varies by model.

- 2.2 kW (3 HP) 230V/460V Drives
Provide a minimum of 8.5 mm (0.33 in.) clearance between units.
- All Other Drive Ratings
No clearance is required between units.

Debris Label

The drive is shipped with a paper debris label attached to the top side of the plastic housing to cover the cooling vents. Leave the debris label attached during drive installation to protect against debris falling through the vents of the drive housing. To assure proper drive operation, you must remove label before applying power.



ATTENTION: After system installation, remove the debris label from unit. Failure to remove this label may result in overheating or nuisance tripping.

Power Wiring

Precautions



ATTENTION: Remove and lock out power from the drive before you disconnect or reconnect wires or perform service. Verify bus voltage by measuring the voltage between DC- and DC+ on Terminal Block TB2. Do not attempt to service the drive until bus voltage has discharged to zero volts.



ATTENTION: The drive is intended to be commanded by control input signals that will start and stop the motor. A device that routinely disconnects then reapplies input power to the drive for the purpose of starting and stopping the motor should not be used. If it is necessary to use this method of starting and stopping, or if frequent cycling of power is unavoidable, make sure that it does not occur more than once a minute.



ATTENTION: Do not connect power factor correction capacitors to drive output terminals U, V and W (T1, T2 and T3) or component damage could occur.

Terminal Blocks

Terminal R (L1) is not present on single phase drives. Three phase unit terminal block configuration is depicted in the figure below.

Drive Terminal Blocks

Figure 2.1

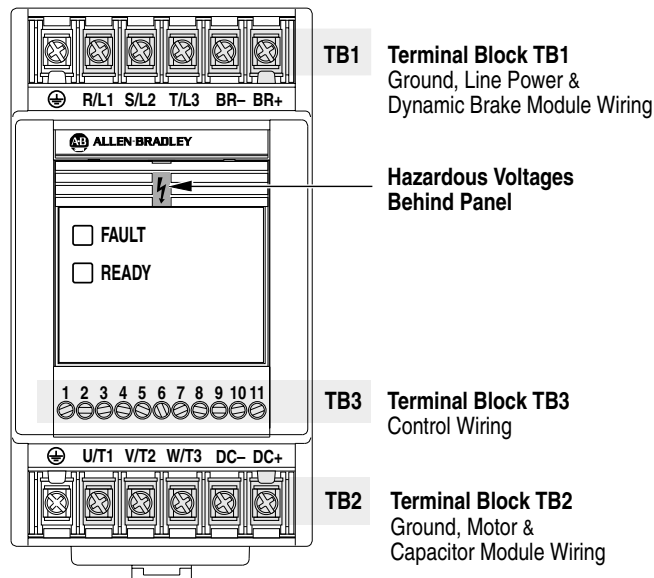

Terminal Block Wiring

Terminal Block Wiring Detail

Figure 2.2

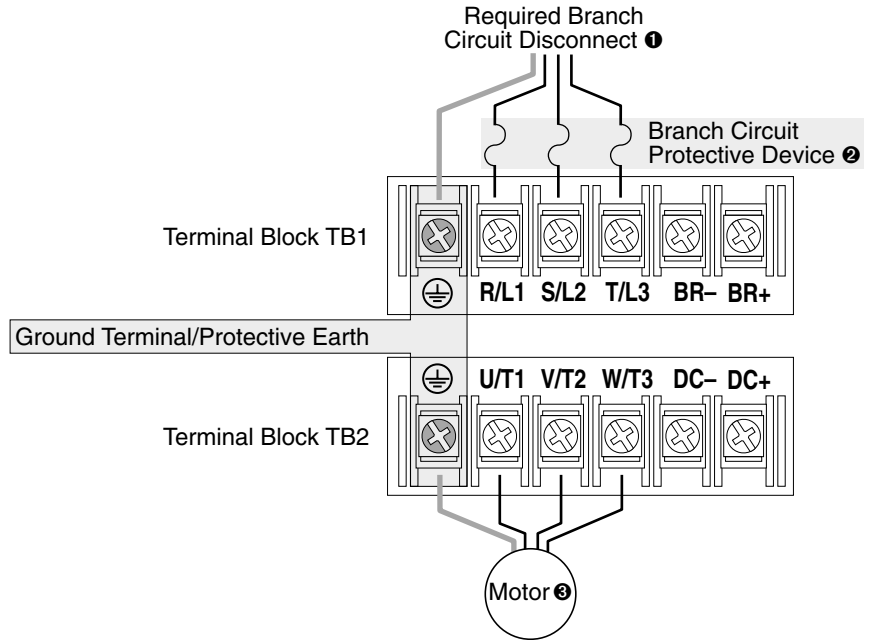

Specifications

Terminal Block TB1 and TB2 Wiring Specifications

Table 2.A

Model	Screw Size	Max./Min. Wire Size ④ <i>mm² (AWG)</i>	Max./Min. Torque <i>Nm (lb.-in.)</i>
4.0 kW (5 HP)	M4	5.26 – 3.31 (10 – 12)	1.35 – 0.90 (12 – 8)
All Other Ratings	M4	3.31 – 0.82 (12 – 18)	1.35 – 0.90 (12 – 8)

- ① For single phase input applications, connect the AC input power to input terminals S (L2) and T (L3).
- ② See Table 2.B for minimum recommended branch circuit protective devices.
- ③ Bulletin 160 Drives are UL Listed (see Appendix A for details) as motor overload protective devices (IEC Class 10 overload). An external overload relay is not required for single motor applications as long as the Drive kW (HP) rating is less than three times larger than the motor kW (HP) rating.
- ④ Each terminal supports up to 2 wires of approved gauge.

Motor Branch Circuit Analysis

Short circuit and overload protection are requirements of any motor branch circuit. Input power conditioning, CE conformance, reflective wave, capacitive current coupling, and motor cable type are important considerations of drive applications.

Branch Circuit Configuration

Figure 2.3

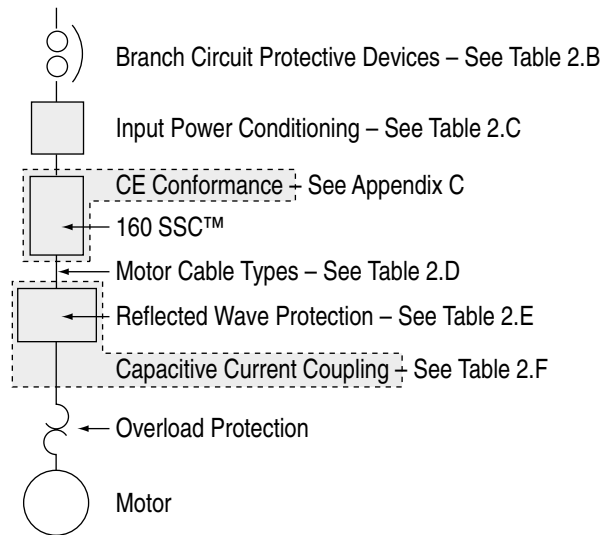

- **Branch Circuit Protective Devices**

A motor branch circuit requires protection against excessive current. This protection can be provided by a fuse, circuit breaker, or manual motor starter. See Table 2.B for a detailed list of these options.

- **Input Power Conditioning**

Certain conditions may exist that could damage a drive in the branch circuit. See Table 2.C for an explanation of problems and solutions.

- **CE Conformance**

See Appendix C for information on CE Conformance.

- **Motor Cable Types**

See Table 2.D for recommended cable types.

- **Reflected Wave Protection**

The use of a drive may result in increased peak-to-peak voltage at the motor. See Table 2.E for an explanation of motor insulation limitations versus cable lengths.

- **Capacitive Current Coupling**

High speed voltage switching causes AC coupling from motor cables to ground terminal/protective earth. See Table 2.F for cable length recommendations.

- **Overload Protection**

All motor branch circuits require overload protection. The Bulletin 160 Drive is UL listed to provide protection (IEC Class 10 overload) without an overload relay. Separate overload relays are required in multi-motor applications or if the drive kW (HP) rating is more than three times larger than the motor kW (HP) rating.

Branch Circuit Protective Devices

Fusing

The Bulletin 160 Smart Speed Controller has been UL tested and approved for use with input fuses. The ratings in the table below are the minimum recommended values for use with each drive rating. The devices listed in this table are provided to serve as a guide. Other devices which meet the requirements of UL508C and UL489 with similar trip characteristics may be used in order to meet local or national electrical codes.

Bulletin 140 Manual Motor Starters/UL489 Circuit Breakers

When using Bulletin 140 manual motor starters or UL489 rated circuit breakers, the guidelines listed below must be followed in order to meet the NEC requirements for branch circuit protection.

- Bulletin 140 manual motor starters can be used in single and group motor applications.
- In single motor applications, a fuse or UL489 rated circuit breaker is required ahead of the Bulletin 140 manual motor starter.
- In group motor installations, the Bulletin 140 can be used for protection of an individual motor within the group and “one set” of fuses or a UL489 rated circuit breaker serves as the Branch Circuit Protective Device for the entire “Group Installation”.
- Bulletin 140M manual motor starters can be used in single and group motor applications without additional short circuit protection. Refer to the technical support literature for the 140M for more details.

Minimum Recommended Branch Circuit Protective Devices ❶ Table 2.B

Voltage Rating	Drive Rating <i>kW (HP)</i>	Fuse Rating ❷	UL489 Rated Circuit Breaker <i>Amps</i>	Bulletin 140/140M Manual Motor Starter <i>Amps</i>
Single Phase 230V	0.37 (0.5)	6	16	16
	0.55 (0.75)	10	16	16
	0.75 (1)	15	16	16
	1.5 (2)	30	20	20
Three Phase 230V	0.37 (0.5)	6	16	16
	0.55 (0.75)	6	16	16
	0.75 (1)	10	16	16
	1.5 (2)	15	16	16
	2.2 (3)	20	20	20
4.0 (5)	30	30	30	
Three Phase 460V	0.37 (0.5)	4	6	6
	0.55 (0.75)	4	6	6
	0.75 (1)	5	6	6
	1.5 (2)	8	16	16
	2.2 (3)	15	16	16
4.0 (5)	20	20	20	

❶ The maximum branch circuit protection rating is limited to four times the rated output current of the drive or 30A, whichever is less.

❷ Fuse class CC, J, BS88, VDE 06366/gG, IEC 269-1/gG, EN60269 part 1 and 2 type gG

Input Power Conditioning

The drive is suitable for direct connection to input power within the rated voltage of the drive (see Appendix A). Listed in Table 2.C are certain input power conditions which may cause component damage or reduction in product life. If any of the conditions exist, as described in Table 2.C, install one of the devices listed under the heading *Corrective Action* on the line side of the drive.

Important: Only one device per branch circuit is required. It should be mounted closest to the branch and sized to handle the total current of the branch circuit.

Input Power Conditions

Table 2.C

Input Power Condition	Corrective Action
Low Line Impedance (less than 1% line reactance)	<ul style="list-style-type: none"> • Check Line Impedance • Line Reactor (See Appendix B) • or Isolation Transformer
Available short circuit currents (fault currents) greater than 100,000 Amps	<ul style="list-style-type: none"> • Check Supply Transformer • Line Reactor (See Appendix B) • or Isolation Transformer
Greater than 120 kVA supply transformer	<ul style="list-style-type: none"> • Line Reactor (See Appendix B) • or Isolation Transformer
Line has power factor correction capacitors	<ul style="list-style-type: none"> • Line Reactor (See Appendix B) • or Isolation Transformer
Line has frequent power interruptions	<ul style="list-style-type: none"> • Line Reactor (See Appendix B) • or Isolation Transformer
Line has intermittent noise spikes in excess of 6000V (lightning)	<ul style="list-style-type: none"> • Line Reactor (See Appendix B) • or Isolation Transformer

Motor Cable Types

A variety of cable types are acceptable for variable speed drive installations. For many installations, *unshielded* cable is adequate, provided it can be separated from sensitive circuits. As an approximate guide, allow a spacing of 1 meter (3.3 feet) for every 10 meters (33 feet) of unshielded length. If you cannot separate motor cables from sensitive circuits, or if you must run motor cables from multiple drives (more than three) in a common conduit or cable tray, *shielded* motor cable is recommended to reduce system noise.

Motor cables should be four-conductor with the ground lead and shield (if using shielded cable) connected to the drive ground terminal and the motor frame ground terminal.

Table 2.D provides the recommended wire type for both wet and dry installations as defined by NEC 1996 (70-31). These recommendations are based upon a variety of factors such as insulation thickness, susceptibility to moisture and susceptibility to nicks and cuts during installation.

Recommended Cable Type

Table 2.D

Condition	Insulation Type	Example
Dry	PVC ❶	THHN
	XLPE	XHHW-2
Wet	XLPE	XHHW-2

❶ For input power voltages in excess of 264V AC, or motor cable distances greater than 15 meters (50 feet), wire with XLPE insulation is recommended.

Long Motor Cable Effects

Reflected Wave Protection

The drive should be installed as close to the motor as possible. Installations with long motor cables may require the addition of external devices to limit voltage reflections at the motor (reflected wave phenomena). See Table 2.E for recommendations.

Important: Both Reflected Wave and Capacitive Current Considerations need to be taken into account when determining motor cable lengths (see Table 2.E and Table 2.F). The use of an external device to limit reflected wave phenomenon may effect the accuracy of Bulletin 160 current sensing.

The reflected wave data applies to all frequencies 2 to 8 kHz. For 230V ratings, the maximum cable length recommendations are the same as the capacitive current recommendations (see Table 2.F).

Cable Length Recommendations – Reflected Wave

Table 2.E

380-460V Ratings	Motor Insulation Rating	Motor Cable Only				RWR at Drive ❶				Reactor at Motor			
		Shielded		Unshielded		Shielded		Unshielded		Shielded		Unshielded	
		feet	meters	feet	meters	feet	meters	feet	meters	feet	meters	feet	meters
4.0 kW (5 HP)	1000 Vp-p	45	13.7	20	6.1	525	160	600	183	325	99.1	300	91.5
	1200 Vp-p	90	27.4	40	12.2	525	160	600	183	525	160	425	130
	1600 Vp-p ❷	525	160	475	145	525	160	600	183	525	160	600	183
2.2 kW (3 HP)	1000 Vp-p	40	12.2	40	12.2	525	160	600	183	225	68.6	250	76.2
	1200 Vp-p	90	27.4	60	18.3	525	160	600	183	325	99.1	425	130
	1600 Vp-p ❷	525	160	500	152	525	160	600	183	525	160	600	183
1.5 kW (2 HP)	1000 Vp-p	40	12.2	40	12.2	425	130	600	183	325	99.1	300	91.5
	1200 Vp-p	90	27.4	60	18.3	425	130	600	183	425	130	450	137
	1600 Vp-p ❷	500	152	500	152	425	130	600	183	540	165	600	183
0.75 kW (1 HP)	1000 Vp-p	55	16.8	40	12.2	325	99.1	600	183	325	99.1	350	107
	1200 Vp-p	125	38.1	60	18.3	325	99.1	600	183	500	152	450	137
	1600 Vp-p ❷	500	152	500	152	325	99.1	600	183	500	152	600	183
0.55 kW (0.75 HP)	1000 Vp-p	45	13.7	40	12.2	300	91.5	600	183	300	91.5	300	91.5
	1200 Vp-p	125	38.1	60	18.3	300	91.5	600	183	500	152	500	152
	1600 Vp-p ❷	500	152	500	152	300	91.5	600	183	500	152	600	183
0.37 kW (0.5 HP)	1000 Vp-p	45	13.7	90	27.4	300	91.5	425	130	300	91.5	425	130
	1200 Vp-p	125	38.1	180	54.9	300	91.5	425	130	500	152	500	152
	1600 Vp-p ❷	500	152	500	152	300	91.5	425	130	500	152	500	152

❶ Cable lengths listed are for PWM frequencies of 2 kHz. Refer to publication 1204-5.1 for cable length recommendations at other PWM frequencies.

❷ The maximum peak-to-peak voltage of the drive is 1400V due to the minimum on/off time software. Reflective Wave Testing has been done on cable lengths up to 160 meters (600 feet). See Table 2.F for capacitive current recommendations.

Capacitive Current Coupling

AC coupling exists from motor cables to ground terminal/protective earth. The current produced by this coupling is referred to as capacitive current. The drive current is the combination of capacitive current and motor current. Because motor current is monitored for overload protection, the table below lists the maximum cable length recommendations that will assure a capacitive current error of less than 15 percent.

Cable Length Recommendations — Capacitive Current

Table 2.F

380-460V Ratings	kHz	Motor Cable Only				RWR at Drive ❶				Reactor at Motor			
		Shielded ❷		Unshielded		Shielded ❷		Unshielded		Shielded ❷		Unshielded	
		<i>feet</i>	<i>meters</i>	<i>feet</i>	<i>meters</i>	<i>feet</i>	<i>meters</i>	<i>feet</i>	<i>meters</i>	<i>feet</i>	<i>meters</i>	<i>feet</i>	<i>meters</i>
4.0 kW (5 HP)	2	350	107	600	183	300	91.5	600	183	400	122	600	183
	4	425	130	600	183	350	107	600	183	450	137	600	183
	8	475	145	500	152	❶				450	137	500	152
2.2 kW (3 HP)	2	360	110	600	183	280	85.4	600	183	400	122	600	183
	4	375	114	600	183	275	83.8	600	183	400	122	600	183
	8	400	122	500	152	❶				400	122	500	152
1.5 kW (2 HP)	2	300	91.5	550	168	275	83.8	600	183	300	91.5	600	183
	4	300	91.5	550	168	275	83.8	600	183	300	91.5	500	152
	8	325	99.1	500	152	❶				350	107	500	152
0.75 kW (1 HP)	2	200	61	375	114	200	61	425	130	225	68.6	400	122
	4	225	68.6	375	114	200	61	425	130	225	68.6	375	114
	8	250	76.2	375	114	❶				225	68.6	400	122
0.55 kW (0.75 HP)	2	180	54.9	350	107	180	54.9	375	114	180	54.9	350	107
	4	180	54.9	350	107	180	54.9	375	114	180	54.9	350	107
	8	180	54.9	350	107	❶				180	54.9	350	107
0.37 kW (0.5 HP)	2	100	30.5	325	99.1	100	30.5	350	107	100	30.5	300	91.5
	4	100	30.5	325	99.1	100	30.5	350	107	100	30.5	350	107
	8	100	30.5	325	99.1	❶				100	30.5	350	107
200-240V Ratings	No Reactor				RWR at Drive ❶				Reactor at Motor				
0.37 to 4.0 kW (0.5 to 5 HP) 2 through 8 kHz	Shielded ❷		Unshielded		Shielded ❷		Unshielded		Shielded ❷		Unshielded		
	<i>feet</i>	<i>meters</i>	<i>feet</i>	<i>meters</i>	<i>feet</i>	<i>meters</i>	<i>feet</i>	<i>meters</i>	<i>feet</i>	<i>meters</i>	<i>feet</i>	<i>meters</i>	
	525	160	600	183	❸				525	160	600	183	

❶ Not recommended for use above 4 kHz PWM Frequency.

❷ When using shielded cable at lightly loaded conditions, cable length recommendations for drives rated 0.75 kW (1 HP) and below are 61 meters (200 feet).

❸ Not recommended for 230V applications.

Control Wiring

Requirements

- Run all signal wiring in either a shielded cable or separate metal conduit.
- Connect shield wire only at TB3 Common terminals (3 and 7).
- Do not exceed control wiring length of 15 meters (50 feet). Control signal cable length is highly dependent on electrical environment and installation practices. To improve noise immunity, the control terminal block Common must be connected to ground terminal/protective earth.
- Use Belden 8760 (or equivalent) — 18 AWG (0.750 mm²), twisted pair, shielded or 3 conductor.

Specifications

Control Terminal Block TB3 Wiring Specifications

Table 2.G

Terminal Block	Max./Min. Wire Size <i>mm² (AWG)</i>	Max./Min. Torque <i>Nm (lb.-in.)</i>
TB3	2.5 – 0.5 (14 – 22)	0.8 – 0.4 (8 – 4)

Important Precautions



ATTENTION: The drive is supplied with an internal 12V supply. Dry contact or open collector inputs are required for discrete control inputs. If an external voltage is applied, component damage could occur.

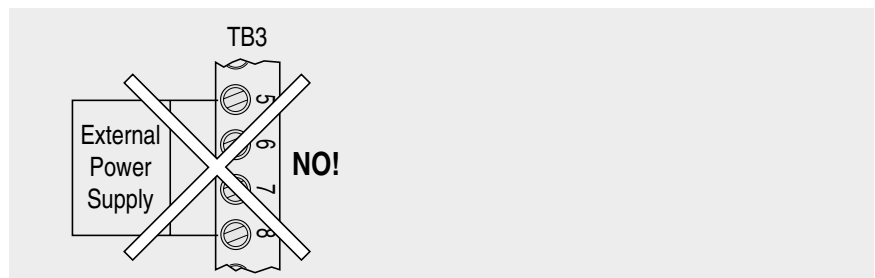

ATTENTION: The drive start/stop and enable control circuitry includes solid-state components. If hazards due to accidental contact with moving machinery or unintentional flow of liquid, gas or solids exist, an additional hardwired stop circuit is required to remove AC input power to the drive. When AC input power is removed, there will be a loss of inherent regenerative braking effect and the motor will coast to a stop. An auxiliary braking method may be required.

Control Wiring Considerations

Wiring Diagram Key

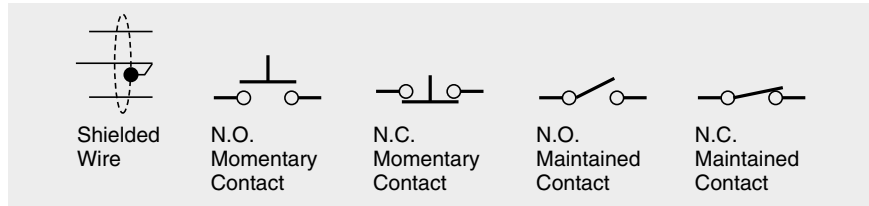

General Control Wiring Advisories

The figure below lists the control wiring requirements for all two wire control input modes (P46 - [Input Mode] settings 1 and 4 – 9). The requirements specific to each input mode are shown separately for that mode.

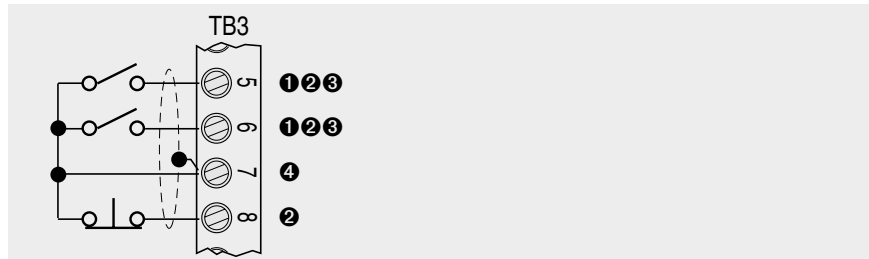

- ❶ Run input must be maintained. After a stop command, either a Run Forward or Run Reverse input must be toggled to start the drive.
- ❷ Internal 12V supply. Contact closure or open collector input required. Refer to Appendix A for solid state control input specifications.
- ❸ If both Run Forward and Run Reverse inputs are closed at the same time, an undetermined state could occur.
- ❹ Control signal cable length is highly dependent on electrical environment and installation practices. To improve noise immunity, TB3 Common must be connected to ground terminal/protective earth. For control wiring installations greater than 15 meters (50 feet) in length, an optional 24V DC interface module is recommended. See Appendix A for ordering information.

Control Methods and Selection Guide

You can use P46 - [Input Mode] to select the control method for start, stop, and direction control. Control can be performed from the Control Terminal Block (TB3) or the optional Program Keypad Module or the Remote Programming Adapter via cable to either a Remote Keypad or a CopyCat Keypad depending on the P46 - [Input Mode] setting being used. The default setting is 0 which means that only the Control Terminal Block will be active for control. If any other input mode is needed (1-9) you must have a device for changing the input mode such as a Program Keypad Module (160-P1). Table 2.H is a guide to wiring diagrams associated with each P46 - [Input Mode] setting.

Important: After a Stop input, a Run command (either Run Forward, Run Reverse or Start) must be toggled to run again. This is true for all P46 - [Input Mode] settings *except* setting 3. See the **Attention** statement below.



ATTENTION: Hazard of injury exists due to unintended operation. When P46 - [Input Mode] is set to 3, and the Run input is maintained, the Run inputs do not need to be toggled after a Stop input for the drive to run again. A Stop function is provided only when the Stop input is active (open).

Control Selection by Input Mode

Table 2.H

P46 Setting	Description	Reference
0	Three-Wire control (factory default)	Figure 2.4
1	Two-Wire Run Forward/Run Reverse control	Figure 2.5
2 ❶	Program, Remote, CopyCat Keypad or Communication Module control	Figure 2.6
3	Momentary Run Forward/Run Reverse control	Figure 2.7
4	Two-Wire Accel/Decel control	Figure 2.8
5	Two-Wire Enable control	Figure 2.9
6 ❶	Two-Wire TB3 control/Keypad or Communication control	Figure 2.10
7	Two-Wire Frequency Select control	Figure 2.11
8	Two-Wire Preset control (Analog Signal Follower Models Only)	Figure 2.12
9	Two-Wire PI control (Analog Signal Follower Models Only)	Figure 2.13

❶ When using Firmware Versions FRN 7.05, 7.04 & 7.03, input modes 2 and 6 are the only modes which allow a serial option, such as 160-DN2 or 160 RS1, to command the drive to run or stop.

PI Control

Firmware Version FRN 7.06 allows activation of PI control in P46 - [Input Mode] settings 0 through 7 and 9 listed in Table 2.H. Refer to page 5-17 for PI Control Setup and Activation instructions.

Users of Firmware Version FRN 7.05 and earlier can only use P46 - [Input Mode] setting 9 to activate PI control. Refer to page 5-17 for PI Control Setup and Activation instructions.

P46 Setting 0 - Three-Wire Control (Factory Default)

This input mode provides a typical three wire control function where a momentary start input will command the drive to start.

Three-Wire control – Factory Default

Figure 2.4

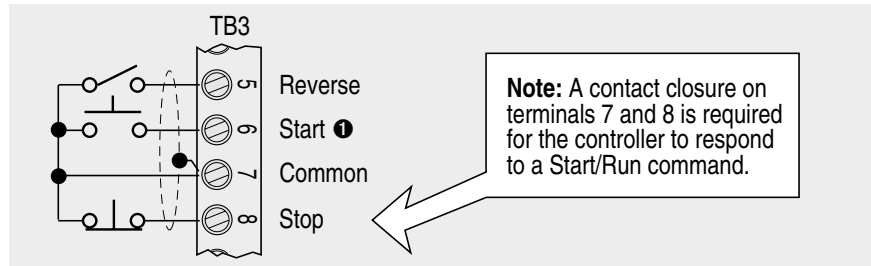

❶ Start input can be a momentary input.

P46 Setting 1 - Two-Wire Run Forward/Run Reverse Control

This input mode provides a typical two wire control function where a maintained Run Forward or Run Reverse input will provide both a directional and start command to the drive. Opening the Run Forward or Run Reverse input will command the drive to stop in accordance with the P34 - [Stop Mode] setting. The stop switch (TB3-7 and 8) is not required but can be wired as an Auxiliary Stop if desired.

Two-Wire Run Forward/Run Reverse control

Figure 2.5

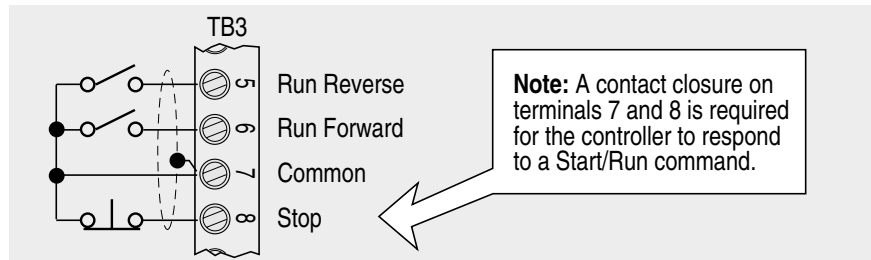

P46 Setting 2 - Program Keypad or Communication Module Control

This input mode activates the Start and Reverse functions from either the Program Keypad Module (PKM), Remote Keypad Module, CopyCat Keypad Module or plug in communication modules and deactivates the Start and Reverse inputs on the control terminal block (TB3). Note: the frequency reference can be controlled from the keypad modules or communication modules by setting P59 - [Frequency Select] to a setting of "1". The frequency will then be controlled by the value programmed into P58 - [Internal Frequency].

Program Keypad Module control

Figure 2.6

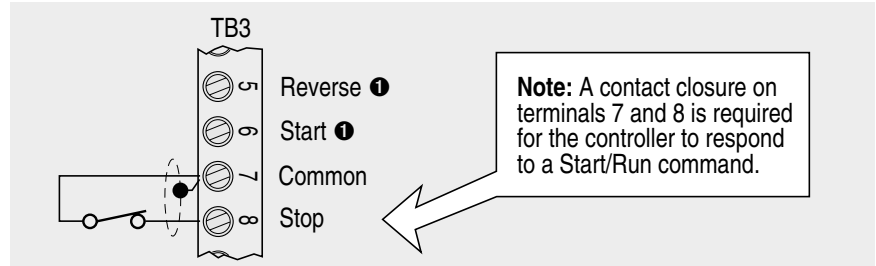

- ❶ When performing start and reverse operations from the Program Keypad Module, Remote Keypad Module, CopyCat Keypad Module or plug-in communication modules, the Start and Reverse inputs from the Control Terminal Block (TB3) are disabled.

P46 Setting 3 - Momentary Run Forward/Run Reverse Control

This input mode allows the drive to respond to either a momentary or maintained Run Forward or Run Reverse input, but requires a stop input to TB3 terminals 7 and 8 to command the drive to stop. In addition, this is the only input mode that uses "level triggered" control logic, therefore once the stop command is removed or if power is lost and restored, the drive will immediately restart if a maintained Run command is present.

Momentary Run Fwd/Run Rev control

Figure 2.7

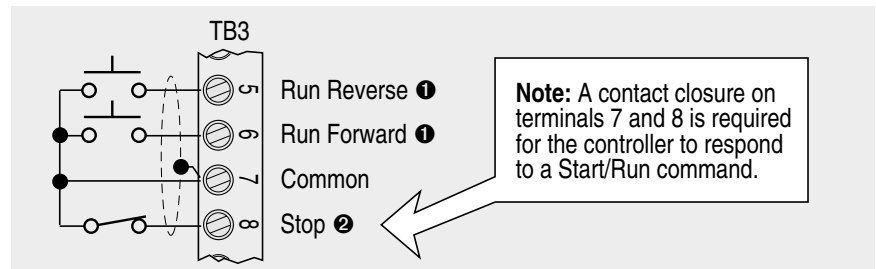

ATTENTION: Hazard of injury exists due to unintended operation. When P46 - [Input Mode] is set to 3, and the Run input is maintained, the Run inputs do not need to be toggled after a Stop input for the drive to run again. A Stop function is provided only when the Stop input is active (open).

- ❶ A momentary or maintained input can be used. If using maintained inputs, please read the **Attention** statement above.
- ❷ A normally closed maintained input is recommended. See **Attention** statement above.

Important: Settings 4 through 9 provide additional flexibility of TB3 control input terminal 8.

P46 Setting 4 - Two-Wire Accel/Decel Control

This input mode is similar to Setting 1 except TB3 terminal 8 provides the function of switching from P30 - [Accel Time 1] and P31 - [Decel Time 1] to P69 - [Accel Time 2] and P70 - [Decel Time 2] for any commanded frequency reference.

Two-Wire Accel/Decel control

Figure 2.8

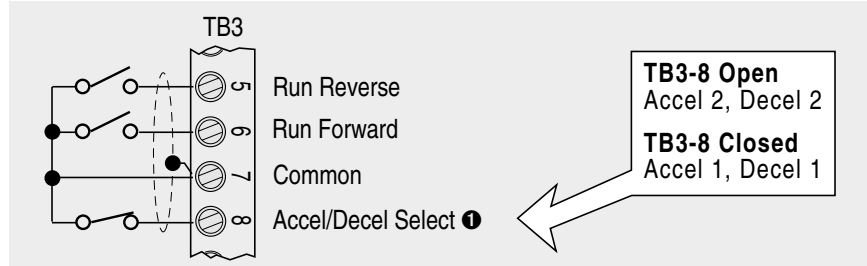

❶ TB3 terminal 8 can be used to clear faults. See Figure 2.14 for details.

P46 Setting 5 - Two-Wire Enable Control

This input mode is similar to Setting 1 except TB3 terminal 8 provides the function of “enable” command. The “enable” input is required for the drive to operate and if opened during operation the programmed P34 - [Stop Mode] will be overridden and the motor will coast to rest.

Two-Wire Enable control

Figure 2.9

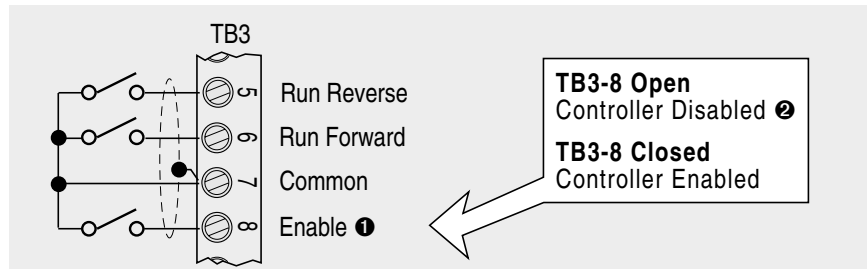

❶ TB3 terminal 8 can be used to clear faults. See Figure 2.14 for details.

❷ When this input is in an open state, the motor will coast to rest.

P46 Setting 6 - Two-Wire TB3 Control/Keypad or Communication Control

This input mode is similar to Setting 1 except TB3 terminal 8 provides the function of switching the start, reverse and speed reference from the Program Keypad Module, Remote Keypad Module, CopyCat Keypad Module, or Communication Module to the control terminal block (TB3).

Two-Wire TB3 control/Keypad or Communication control Figure 2.10

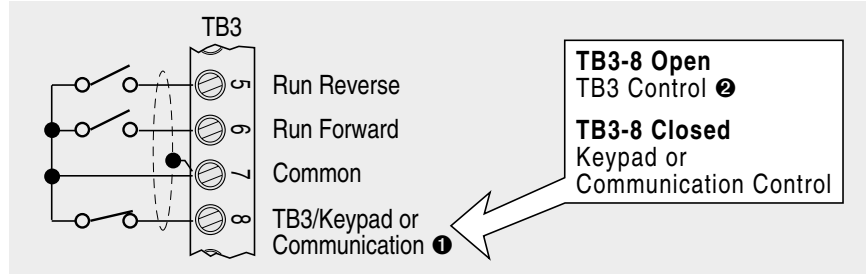

- ❶ TB3 terminal 8 can be used to clear faults. See Figure 2.14 for details.
- ❷ When this input is in an open state the Frequency source is always from the terminal block regardless of the setting of P59 - [Frequency Select].

P46 Setting 7 - Two-Wire Frequency Select Control

This input mode is similar to Setting 1 except TB3 terminal 8 provides the function of switching the frequency reference from the control terminal block (TB3) to the frequency commanded by P58 - [Internal Frequency]. For Analog Signal Follower models this provides the ability to switch from analog control to one preset speed. For Preset Speed models this provides a ninth preset speed via P58 - [Internal Frequency].

Two-Wire Frequency Select control Figure 2.11

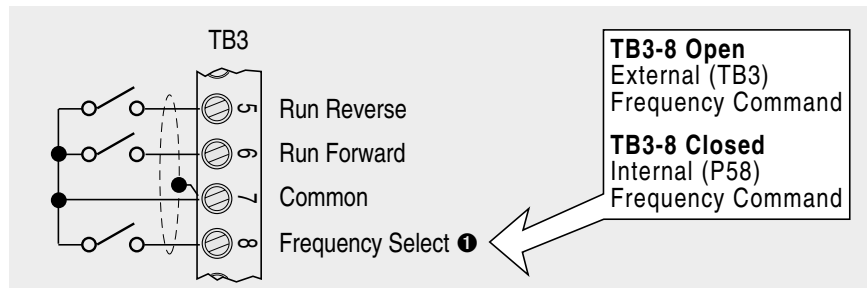

- ❶ TB3 terminal 8 can be used to clear faults. See Figure 2.14 for details.

P46 Setting 8 - Two Wire Preset Speed Control (Analog Models Only)

This input mode is similar to Setting 1 except TB3 terminals 1, 2 and 8 provide the function of preset speeds. Note: All analog functionality is disabled when using this input mode setting.

Two-Wire Preset control

Figure 2.12

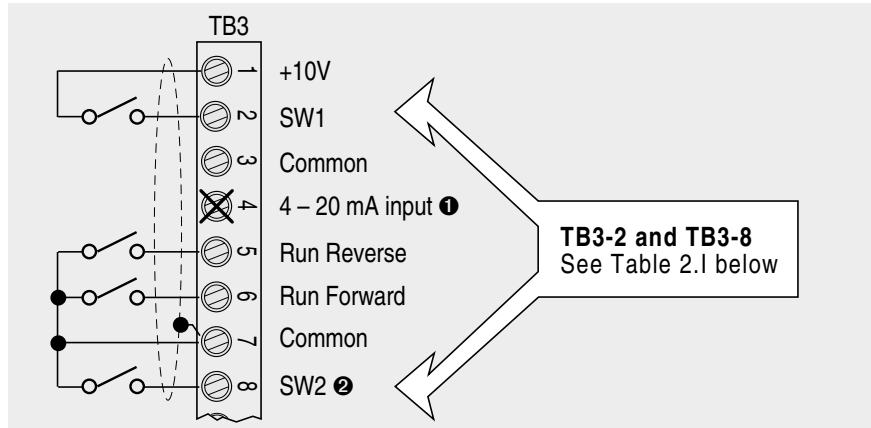

TB3 Terminal 2 and 8 Switch Definitions

Table 2.1

SW2 Position TB3-8	SW1 Position TB3-2	Speed Reference	Accel Rate	Decel Rate
Open (0)	Open (0)	Parameter 61 (Preset 0)	Parameter 30	Parameter 31
Open (0)	Closed (1)	Parameter 62 (Preset 1)	Parameter 30	Parameter 31
Closed (1)	Open (0)	Parameter 65 (Preset 4)	Parameter 69	Parameter 70
Closed (1)	Closed (1)	Parameter 66 (Preset 5)	Parameter 69	Parameter 70

❶ Do not connect to TB3-4 in this mode.

❷ TB3 terminal 8 can be used to clear faults. See Figure 2.14 for details.

P46 Setting 9 - Two-Wire PI Control (Analog Models Only)

This input mode is similar to Setting 1 except TB3 terminal 8 provides the function of PI Control.

Two-Wire PI control

Figure 2.13

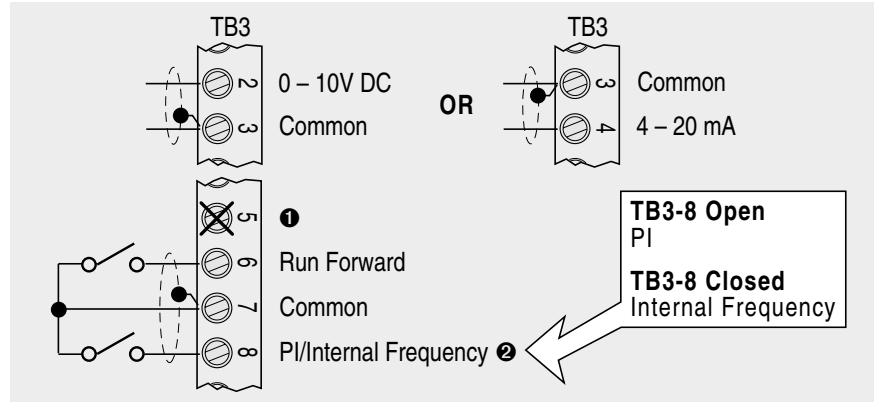

Refer to Chapter 5, *160 PI Control Setup* for a detailed PI Control Setup description.

❶ Do not connect to TB3-5 in this mode.

❷ TB3 terminal 8 can be used to clear faults. See Figure 2.14 for details

Important: For P46 - [Input Mode] settings 4 through 9, Terminal TB3-8 is also used to clear faults. See figure below for details.

TB3-8 – Clear Faults

Figure 2.14

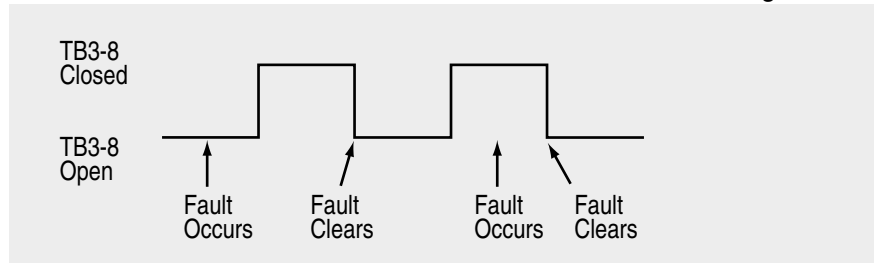

Important: The system programmer is responsible for returning terminal TB3-8 to its original state if necessary.

When connecting a single input such as Run, Stop, Reverse or Preset Speeds to multiple drives, it is important to connect the commons (TB3-7) together for all drives. If they are to be tied into another common (such as earth ground or separate apparatus ground) only one point of the daisy chain of TB3-7 should be connected. Predicting actual performance given the variety of installation possibilities is difficult, however, up to five drives with two meters of cable between have been tested without problems.

Typical Multiple Drive Input Connections

Figure 2.15

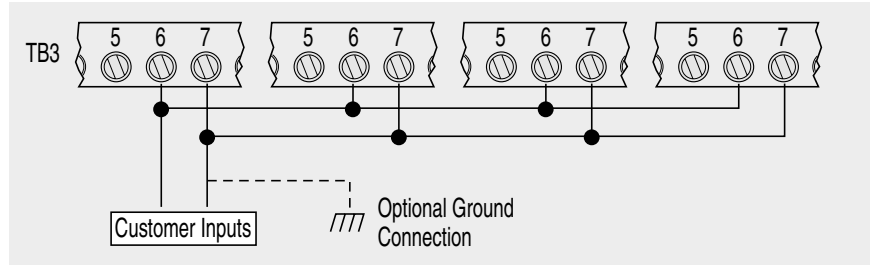

Configurable Relay Output Contacts (P47 Settings)

You can configure the drive’s dry contact Form C output relay to change state based on P47 - [Output Configure] setting and P48 - [Output Threshold] limits. See Chapter 5 for details.

Configurable Relay Output Contacts

Figure 2.16

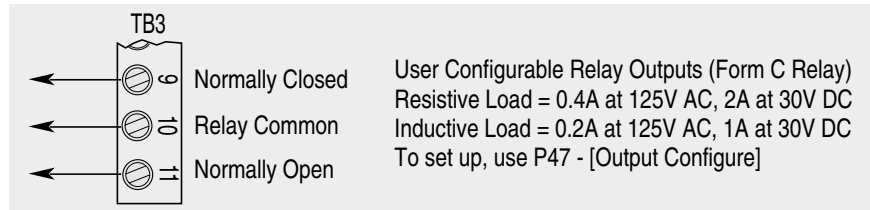

Frequency Source Wiring

Analog Signal Follower Model

You can control the output frequency of the drive via the Control Terminal Block (TB3) using the following methods.

Analog Frequency Sources

Important: Only one frequency source may be connected at a time. If more than one reference is connected at the same time, an undetermined frequency reference will result.

±10V or 0 – 10V DC Frequency Control/Speed Control

Figure 2.17

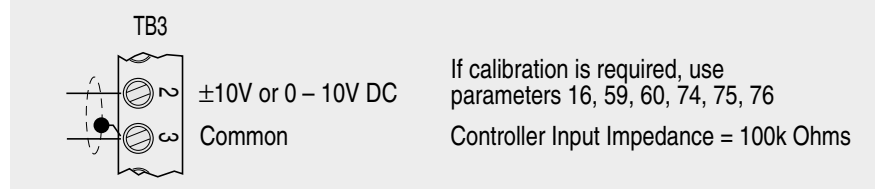

4 – 20 mA Frequency Control/Speed Control

Figure 2.18

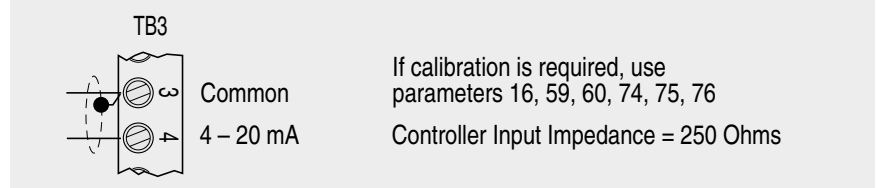

Potentiometer Frequency Control/Speed Control

Figure 2.19

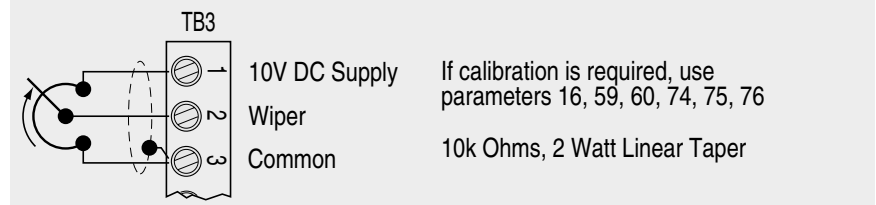

When connecting a single potentiometer to multiple drives it is important to connect commons (TB3-3) together for all drives. TB3-3 (common) and TB3-2 (potentiometer wiper) should be daisy-chained to each drive. All drives must be powered up for the analog signal to be read correctly. Predicting actual performance given the variety of installation possibilities is difficult, however, up to five drives with two meters of cable between have been tested without problems.

Typical Multiple Drive Analog Connection

Figure 2.20

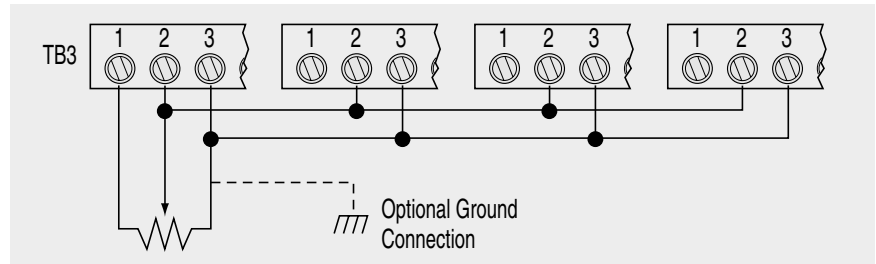

Preset Frequency Sources

The Analog Signal Follower model has a special input mode, P46 setting 8 that allows the drive to be operated via preset speed inputs. See Figure 2.12 and Table 2.I for details.

Preset Speed Model

You can control the output frequency of the drive via the Control Terminal Block (TB3) using dry contacts or open collector inputs to SW1, SW2, and SW3 (see Figure 2.21).

Important: Refer to parameters 61 – 68 in Chapter 5 for the eight preset frequency factory default settings and switch configurations. A program keypad module is required to change the factory default settings.

TB3 Control Wiring for Preset Speed Model

Figure 2.21

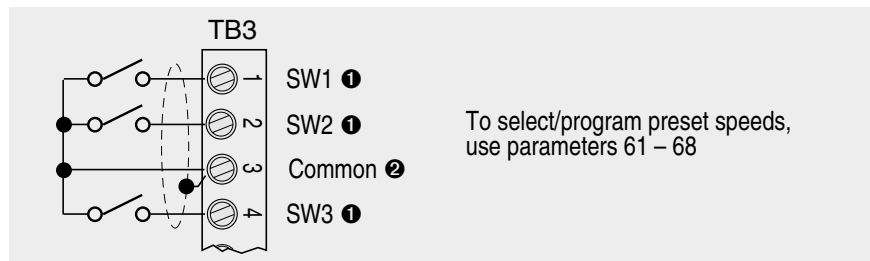

- ❶ Internal 12V supply. Contact closure or open collector input required. Refer to Appendix A for solid state control input specifications.
- ❷ Control signal cable length is highly dependent on electrical environment and installation practices. To improve noise immunity, TB3 Common must be connected to ground terminal/protective earth. For control wiring installations greater than 15 meters (50 feet) in length, an optional 24V DC interface module is recommended. See Appendix A for ordering information.

Analog and Preset Models

Internal Frequency Source

Both the Analog Signal Follower and Preset Speed models have the provision for frequency control via P58 - [Internal Frequency]. This is accomplished by setting P59 - [Frequency Select] to a value of 1. See Chapter 5 for a description of these parameters.

What To Do Next

You should become familiar with the Program Keypad Module operation in Chapter 3 if you need to change any factory default parameter settings for your application.

Then proceed to Chapter 4, *Start-Up* and follow the flow diagram. After applying power, you can program parameters if necessary. Refer to Table 5.A for a list of commonly changed parameters.

Program Keypad Module

The Program Keypad Module is located on the front panel of the drive. This module is only operational when it is installed directly on the drive.

Features

The Program Keypad Module provides the following features:

- 6-digit, 7-segment LED display
- Program Mode Indicator
- Five keys for programming and displaying drive parameters
- Three keys for control inputs to the drive
- Two directional LED indicators

Program Keypad Module

Figure 3.1

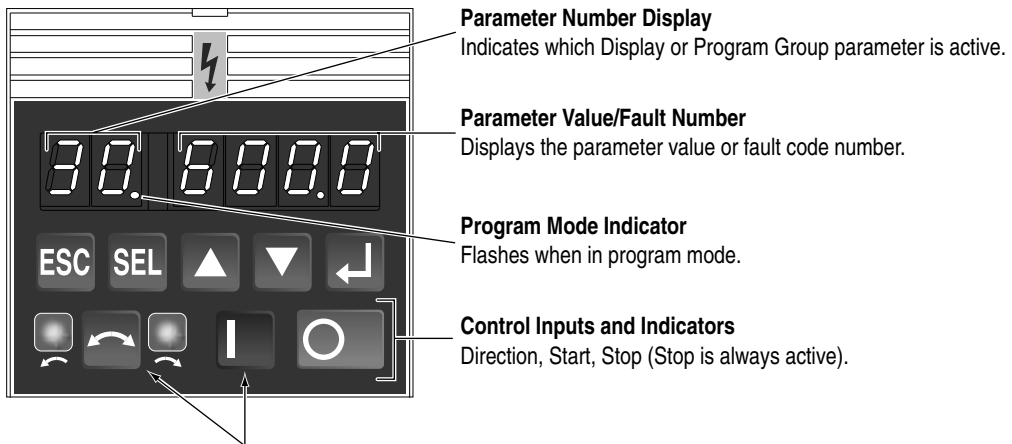

Important: To activate Direction and Start inputs, P46 - [Input Mode] must be set to 2. Power must be cycled or P56 - [Reset Functions] must be set to 2 for the change to take effect.

Display Mode

The drive always powers up in the Display mode. While in this mode you may view all *read only* drive parameters, but not modify them.

Program Mode

You enter the Program mode by pressing the ESCape key. While in this mode, you can edit Program Group parameters by pressing the SElect key. The Program Mode Indicator will flash (see Figure 3.1) indicating the parameter value can be changed. The Enter key (↵) must be pressed to write the new value to memory. Refer to Chapter 5 for programming steps.

Key Functions



Escape

The ESCape key allows you to toggle between the Display and Program modes. When the Program mode is active, this key will disable the editing of a parameter value.



Select

The SElect key enables editing of a parameter value when the Program mode is active. When you press this key, the Program Mode Indicator flashes.



Up/Down Arrow Keys

Use the Up/Down Arrow keys to scroll through a list of parameters, or increase and decrease parameter values. Press and hold either key to increase scrolling speed. Real time frequency adjustment can be achieved when using P58 - [Internal Frequency] and P59 - [Frequency Select]. Refer to Chapter 5 for further information.



Enter

Pressing this key causes the current value displayed to be entered into memory (only while in the Program mode). When you press this key, the Program Mode Indicator remains on, but stops flashing.



Direction LEDs (Indicators)

The appropriate LED will illuminate continuously to indicate the commanded direction of rotation. If the second LED is flashing, the drive has been commanded to change direction, but is still decelerating.

Important: Actual motor rotation could be different if motor leads are not connected properly. Refer to Chapter 4 for details on how to verify correct motor rotation.



Reverse (Change Direction)

This function is only active when P46 - [Input Mode] is set to 2. When active, pressing this key causes the motor to ramp down to 0 Hz and then ramp up to its set speed in the opposite direction. When the motor is running, pressing this key causes the (currently illuminated) LED to flash, indicating motor rotation while decelerating to zero. The other LED will illuminate indicating the commanded direction.



Start

This function is only active when P46 - [Input Mode] is set to 2. When active, pressing this key initiates a start command.



Stop

Pressing the Stop key will cause the motor to stop, using the selected stop mode. Refer to the P34 - [Stop Mode] parameter. If the drive has stopped due to a fault, pressing this key will clear the fault.

Important: The Stop key is always active in all control modes.

Module Removal and Installation



ATTENTION: Ensure that you disconnect line power and wait three minutes before installing or removing the Program Keypad Module. Failure to do so could result in personal injury or death.



ATTENTION: This drive contains ESD (Electrostatic Discharge) sensitive parts and assemblies. Static control precautions are required when installing, testing, servicing or repairing this assembly. Component damage may result if ESD control procedures are not followed. If you are not familiar with static control procedures, reference Publication 8000-4.5.2, “Guarding Against Electrostatic Damage” or any other applicable ESD protection handbook.

Removal

Insert a small screw driver into the slot at top of keypad. Carefully pry back and pivot the module out. Avoid bending or twisting the contact pins located underneath the center portion of the module.

Removing Program Keypad Module

Figure 3.2

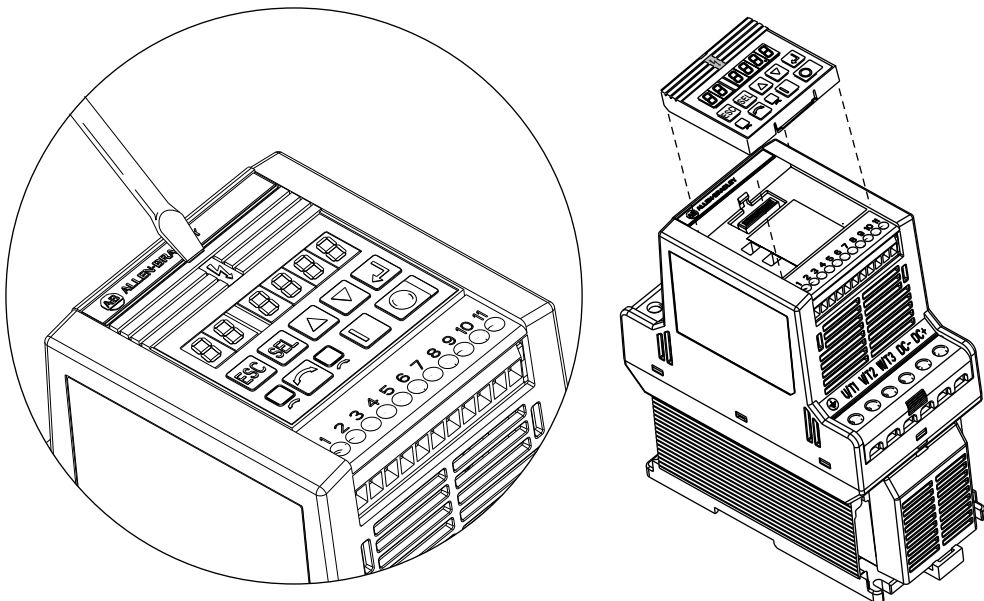

Installation

1. Insert the module, bottom end first, into the drive.
2. Press on the  symbol at the top of the module until it is firmly seated.

It is critical that the Program Keypad Module is firmly seated to ensure circuit integrity.

Installing Program Keypad Module

Figure 3.3

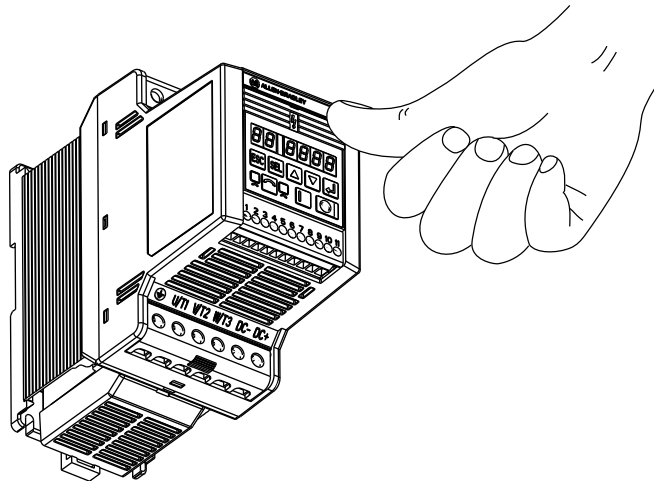

Start-Up

Start-Up Procedures

This chapter guides you through a basic start-up of the drive using factory default parameter settings. The objective is to verify power and control wiring, set motor direction, control motor speed and prepare you for programming parameters (tuning) if necessary. Refer to Chapter 5 for a complete listing and description of parameters and programming information.



ATTENTION: Power must be applied to the drive to perform the following start-up procedure. Some of the voltages present are at incoming line potential. To avoid electric shock hazard or damage to equipment, only qualified service personnel should perform the following procedure. Thoroughly read and understand the procedure before beginning. If an event does not occur while performing this procedure, **Do Not Proceed. Remove Power** by opening the branch circuit disconnect device and correct the malfunction before continuing.

Start-Up Checklist

Verify that the drive is installed per the instructions in Chapter 2, including...

- Drive is mounted on a flat, vertical and level surface.
- Minimum clearance distance between drive and other equipment.
- Proper grounding practices have been followed.
- Proper power and control wiring has been used.
- No external power applied to control inputs.

Verify that AC line power at the disconnect device is within the rated value of the drive.

Disconnect and lock out all incoming power to the drive including incoming AC power to terminals R, S and T (L1, L2 and L3) of TB1.



ATTENTION: A DC Bus voltage may be present at TB1 and TB2 for approximately three minutes after power is removed from the drive.

Verify that the motor leads are connected to the power terminal block TB2, terminals U, V, W (T1, T2, T3).

IMPORTANT: Verify that a closed contact input is present at TB3-8. See Chapter 2, *Control Wiring* for details on TB3-8 functionality when using P46 - [Input Mode] settings 4 through 9.

Confirm that all other control inputs are connected to the correct terminals and are secure.

Remove debris label and reconnect power to drive.

continued on next page

continued from previous page

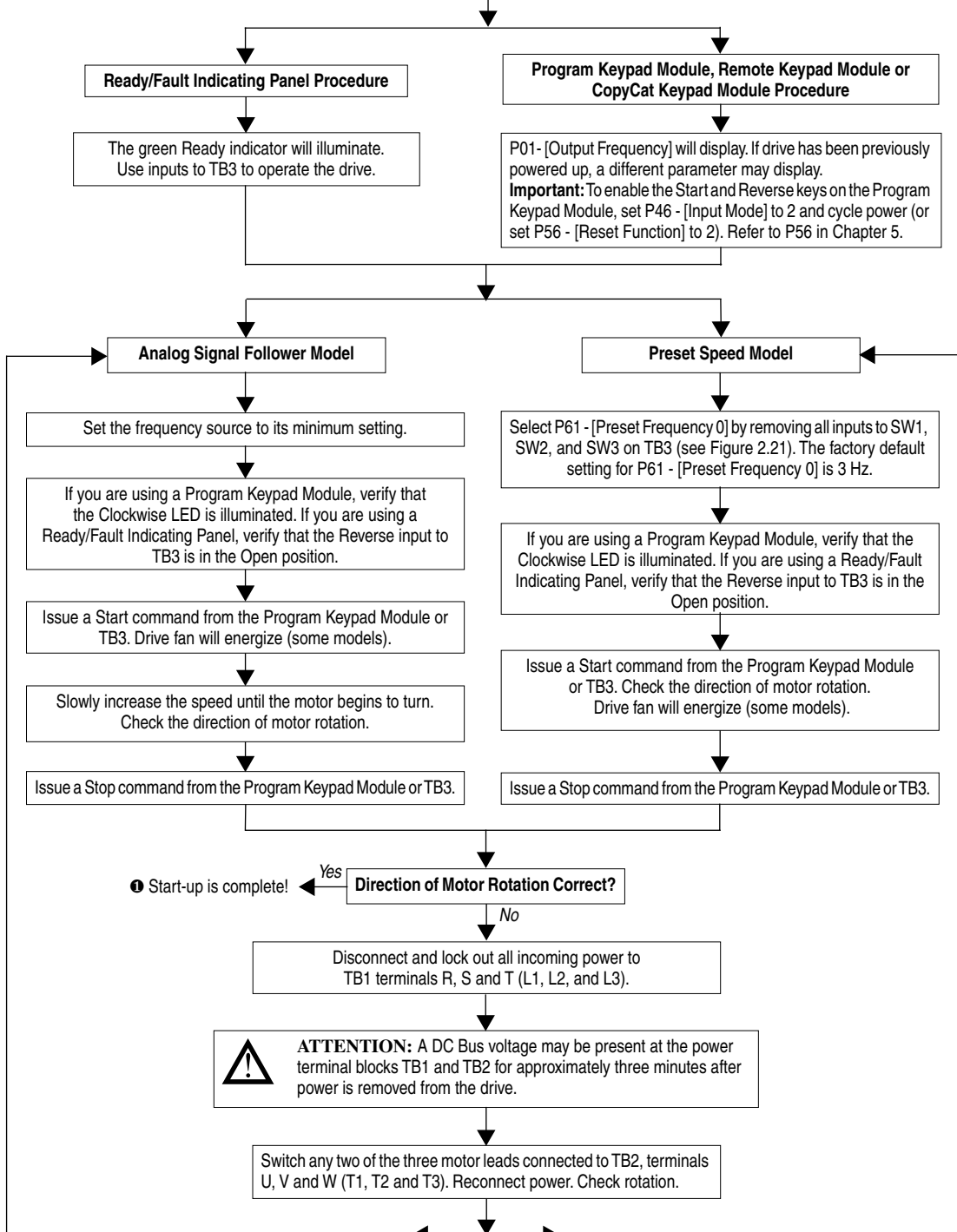

- ❶ After successfully completing start-up, proceed to Chapter 5. If you need to change any factory defaults, you will need a Program Keypad Module or other type of Communication Module.

Parameters and Programming

Overview of Parameters

This chapter describes both Display and Program parameters. Display parameters are *read only* (they cannot be programmed), while Program parameters *can* be changed to fit your motor control requirements. A Program Keypad Module, Remote Keypad Module or CopyCat Keypad Module allow you to view or change parameters. Communication Modules (RS1, DN1 or DN2) allow you to view or change parameters with an additional device. A Ready/Fault Indicating Panel cannot be used to view or change parameters. The table below describes which parameters apply to the Preset Speed and Analog Signal Follower models.

Parameter Type	Analog Signal Follower Model Parameter Numbers	Preset Speed Model Parameter Numbers
Display	1 – 19	1 – 15, 17 – 19
Program	30 – 62, 65, 66, 69 – 76, 78 – 84	30 – 59, 61 – 73, 78 – 80

Some parameters pertain only to either the Analog Signal Follower or Preset Speed model, not both.

	← Indicates that parameter applies only to the Analog Signal Follower Model
	← Indicates that parameter applies only to the Preset Speed Model

Review the factory default settings. These parameters can be changed to meet your specific application requirements with any of the following: Program Keypad Module, Remote Keypad Module or CopyCat Keypad Module. The table below provides a list of parameters that are frequently changed.

Commonly Changed Parameters

Table 5.A

Parameter	Setting	Default Setting
P30 - [Accel Time 1]	Desired accel time.	10.0 sec
P31 - [Decel Time 1]	Desired decel time.	10.0 sec
P33 - [Maximum Frequency]	Maximum frequency required.	60 Hz
P34 - [Stop Mode Select]	Desired stopping mode.	0
P35 - [Base Frequency]	Motor rated nameplate frequency.	60 Hz
P36 - [Base Voltage]	Motor rated nameplate voltage.	460V or 230V
P38 - [Boost Select]	Desired V/F boost setting.	2
P42 - [Motor Overload Current]	Motor nameplate Full Load Amps (FLA).	115%
P43 - [Current Limit]	Desired maximum output current.	150%
P46 - [Input Mode]	Desired control method.	0
P47 - [Output Configure]	Desired output relay function.	0
P56 - [Reset Functions]	Desired drive reset description.	0
P58 - [Internal Frequency]	Desired internal frequency.	60.0 Hz
P59 - [Frequency Select]	Desired frequency source.	0
P61 – P68 - [Preset Frequency 0-7]	Desired preset frequencies.	0-7
P74 – P76 - [Analog Input]	Desired analog input functionality.	0, 0.0, 100.0%

Refer to the *Programming Example* on the next page for instructions.

Important Reset Actions

You must set P56 - [Reset Functions] to 2 or cycle power after changing the setting of P46 - [Input Mode] for the change to take effect.

If you reset to factory defaults, you cannot use the Program Keypad Module for start or reverse control until it is selected using P46 setting 2. **Note:** P56 - [Reset Functions] must be set to 2 or power must be cycled for the change to take effect.











Important: If you cycle power, you must wait a minimum of one minute for the bus to discharge to zero to ensure the change has taken effect.

An F48 - Reprogram Fault can be cleared using the Program Keypad Module, Remote Keypad Module or CopyCat Keypad Module stop button or by cycling input to TB3-8.

Programming Example

The following is an example of the programming steps required to change a *Program Group* parameter setting. In this example, P31 - [Decel Time] is changed from its factory default setting of 10.0 seconds to 2.2 seconds. Refer to Chapter 3 for an explanation of the Program Keypad Module display and programming keys.

Important: To reset ALL values to original factory default settings, refer to P56 - [Reset Defaults].

Action	Description	Keypad Display
	1. To program the value of a <i>Program Group</i> parameter, enter the Program Group by pressing the ESCape key. The Program Mode Indicator will illuminate.	
	2. Press the Up/Down keys until the desired parameter displays. In this case, press the Up key until P31 - [Decel Time] displays.	
	3. Press SElect. The Program Mode Indicator flashes, indicating that you can use the Up/Down keys to change the parameter value.	
	4. Change the decel time value from the factory default of 10.0 seconds to 2.2 seconds by pressing the Down key until 2.2 displays. Important: Continuously holding the Up or Down key will cause the value to increase or decrease as long as the key is pressed.	
	5. When the desired value displays, press the Enter key. This writes the new value to memory. The Program Mode Indicator will stop flashing and the display will flash once indicating that the new value has been accepted.	
	Important: If at any time (while in the program mode) you wish to abort the editing process, press the ESCape key. The original value of the parameter will remain unchanged and you will be exited from the Program mode.	

Display Group Parameters (Read Only)

This group of parameters consists of commonly viewed drive operating conditions such as output frequency, output voltage, output current and frequency command. All parameters in this group are *read only*.

Important: The last user-selected Display Group parameter is saved when power is removed and is displayed by default when power is reapplied.

Display Group (Read Only)			
No.	Parameter Name/Description	Min./Max. Range	Units
01	[Output Frequency] Displays the output frequency at TB2 terminals U, V & W (T1, T2 & T3).	0.0/240.0	0.1 Hz
02	[Output Voltage] Displays the output voltage present at TB2 terminals U, V & W (T1, T2 & T3).	0/Max Voltage	1 Volt
03	[Output Current] Displays the output current present at TB2 terminals U, V & W (T1, T2 & T3).	0/2 x Drive Rated Output Current	0.01A
04	[Output Power] Displays the output power present at TB2 terminals U, V & W (T1, T2 & T3).	0/2 x Rated Drive Output Power	0.01 kW
05	[Bus Voltage] Displays the DC Bus Voltage level.	0/400 - 230V 0/800 - 460V	1 Volt
06	[Frequency Command] Displays the frequency that the drive is commanded to output. This command may come from any of the frequency sources selected by P59 - [Frequency Select] or from a currently selected preset frequency.	0.0/240.0	0.1 Hz
07	[Active Fault] Displays the coded active fault number. If a fault is currently active (has not been cleared) the display will flash. After fault condition is cleared, display will read zero. Refer to P17, P18, and P19 for fault history. See Chapter 6 for fault code descriptions.	0/48	Numeric Value
08	[Heatsink Temperature] Displays the temperature of the drive heatsink. Note: A display value of 69 indicates a temperature of less than 70°C.	69/150	1 Degree C
09	[Drive Status] Displays the status of the drive in a binary coded format. Important: 0 = Inactive, 1 = Active.	0000/1011	Binary Number
<pre> graph LR B3[Bit 3] --> R[Running] B2[Bit 2] --> F[Forward] B1[Bit 1] --> A[Accel] B0[Bit 0] --> D[Decel] </pre>			
10	[Drive Type] Used by Rockwell Automation field service personnel.	Numeric Value	Numeric Value
11	[Firmware Version] Displays version of drive firmware. Used by Rockwell Automation field service personnel.	Fixed Value	Numeric Value

Display Group (Read Only)

No.	Parameter Name/Description	Min./Max. Range	Units
-----	----------------------------	-----------------	-------

12 [Input Status] 0000/1111 Binary Number
 Displays the open (0) and closed (1) state of the inputs to TB3 in binary coded format as follows:

	Bit 3 Polarity	Bit 2 TB3-6	Bit 1 TB3-8	Bit 0 TB3-5
Input Mode 0 (3-Wire)	0 = Positive Analog Input	Start	Stop	Reverse
Input Mode 1 (2-Wire)		Run Forward	Stop	Run Reverse
Input Mode 2 (Keypad)	1 = Negative Analog Input	N/A	Stop	N/A
Input Mode 3 (Mom. Run Fwd./Rev.)		Run Forward	Stop	Run Reverse
Input Mode 4 (Accel/Decel)		Run Forward	0 = Accel 2/Decel 2 1 = Accel 1/Decel 1	Run Reverse
Input Mode 5 (Coast to Rest)		Run Forward	Coast to Rest Stop	Run Reverse
Input Mode 6 (TB3 Control/ Keypad or Comm.)		Run Forward	0 = TB3 Control 1 = Keypad or Comm.	Run Reverse
Input Mode 7 (Frequency Select)		Run Forward	0 = Analog Frequency Select 1 = Internal Frequency Select	Run Reverse
Input Mode 8  (SF1 Preset Speed)		Run Forward	0 = Open 1 = Closed	Run Reverse
Input Mode 9 (2-Wire PI control)		Run Forward	0 = PI 1 = Internal Frequency Select	Run Reverse

 Status of Bit 3 for Input Mode 8 is TB3-2 is: 0 = Open, 1 = Closed.

13 [Power Factor Angle] 0.0/180.0 0.1 degrees
 Displays the angle in electrical degrees between motor voltage and motor current.

14 [Memory Probe Display] Numeric Value Numeric Value
 Used by Rockwell Automation field service personnel.

15 [Preset Status] Preset – 0000/0111 Binary Number
 Displays the open (0) and closed (1) state of TB3 inputs SW1, SW2 and SW3 in binary coded format.

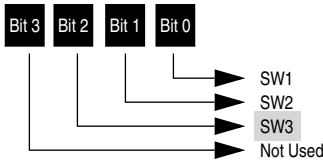



Analog – 0000/0011

16 [Analog Input] -150.0/+150.0 0.1%

Displays the analog input as a percent of full scale. Used in setting P60 - [Zero Offset], P75 - [Analog Input Minimum], and P76 - [Analog Input Maximum].

Important: On initial set up of the drive, apply a 0V or 4 mA analog command to the drive. Once applied, if the value of this parameter displays something other than zero, program that value into P60 - [Zero Offset]. Please note that the value of [Zero Offset] will be subtracted from the value of this parameter.

 This parameter applies only to the Analog Signal Follower model.

 This TB3 input applies only to the Preset Speed model.

Display Group (Read Only)

No.	Parameter Name/Description	Min./Max. Range	Units
17	[Fault Buffer 0] This parameter stores the last fault that occurred. If the same fault occurs multiple times in a row, it will be stored once. After a "reset defaults" (P56) this will set this parameter to F48 - Reprogram Fault. As faults occur, the previous value of this parameter is moved to P18 - [Fault Buffer 1].	0/48	Numeric Value
18	[Fault Buffer 1] This parameter stores the second most recent fault that occurred. After a "reset defaults" (P56) this will set this parameter to 0 (No active fault). As faults occur, the value of this parameter will be overwritten by P17 - [Fault Buffer 0]. The previous value of this parameter is moved to P19 - [Fault Buffer 2].	0/48	Numeric Value
19	[Fault Buffer 2] This parameter stores the third most recent fault that occurred. After a "reset defaults" (P56) this will set this parameter to 0 (No active fault). As faults occur, the value of this parameter will be overwritten by P18 - [Fault Buffer 1].	0/48	Numeric Value

Program Group Parameters

This group contains parameters whose values *can* be programmed. Refer to *Programming Example* earlier in this chapter. Unless otherwise stated, parameters that are programmed while the drive is running take immediate effect.

Program Group

No.	Parameter Name/Description	Min./Max. Range	Units	Factory Default
30	[Accel Time 1] Time for the drive to ramp from 0.0 Hz. to P33 - [Maximum Frequency]. The rate is linear for any increase in command frequency unless P53 - [S-Curve] is set to a value other than "0". Setting this to 0.0 sec. gives 0.1 sec acceleration with the initial current limit turned off. This allows quicker acceleration times for low inertia systems. For medium to high inertia systems, the minimum value should be 0.1 sec.	0.0/600.0	0.1 Seconds	10.0 Seconds

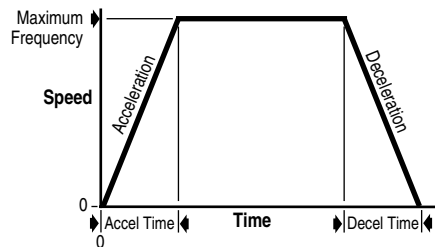

Program Group																		
No.	Parameter Name/Description	Min./Max. Range	Units	Factory Default														
31	<p>[Decel Time 1]</p> <p>Time for the drive to ramp from P33 - [Maximum Frequency] to 0.0 Hz. The rate is linear for any decrease in command frequency unless P53 - [S-Curve] is set to a value other than 0.</p> <p>● Minimum deceleration time must be set based on the applied motor size. To guard against premature drive failure, do not set P31 - [Decel Time 1] or P70 - [Decel Time 2] below the minimum value listed in the table below.</p> <table border="1"> <thead> <tr> <th>230 and 460V Motor Sizes</th> <th>Minimum Deceleration Settings</th> </tr> </thead> <tbody> <tr> <td>4.0 kW (5 HP)</td> <td>0.7 seconds</td> </tr> <tr> <td>2.2 kW (3 HP)</td> <td>0.6 seconds</td> </tr> <tr> <td>1.5 kW (2 HP)</td> <td>0.2 seconds</td> </tr> <tr> <td>0.75 kW (1 HP)</td> <td>0.1 seconds</td> </tr> <tr> <td>0.55 kW (0.75 HP)</td> <td>0.1 seconds</td> </tr> <tr> <td>0.37 kW (0.5 HP)</td> <td>0.1 seconds</td> </tr> </tbody> </table>	230 and 460V Motor Sizes	Minimum Deceleration Settings	4.0 kW (5 HP)	0.7 seconds	2.2 kW (3 HP)	0.6 seconds	1.5 kW (2 HP)	0.2 seconds	0.75 kW (1 HP)	0.1 seconds	0.55 kW (0.75 HP)	0.1 seconds	0.37 kW (0.5 HP)	0.1 seconds	●/600.0	0.1 Seconds	10.0 Seconds
230 and 460V Motor Sizes	Minimum Deceleration Settings																	
4.0 kW (5 HP)	0.7 seconds																	
2.2 kW (3 HP)	0.6 seconds																	
1.5 kW (2 HP)	0.2 seconds																	
0.75 kW (1 HP)	0.1 seconds																	
0.55 kW (0.75 HP)	0.1 seconds																	
0.37 kW (0.5 HP)	0.1 seconds																	
32	<p>[Minimum Frequency]</p> <p>Lowest frequency that drive will output continuously.</p>	0/240	1 Hz	0 Hz														
33	<p>[Maximum Frequency]</p> <p>Highest frequency the drive will output.</p> <p>This parameter cannot be changed while running. The value of this parameter setting must be greater than the value set in P32 - [Minimum Frequency].</p>	0/240	1 Hz	60 Hz														
34	<p>[Stop Mode Select]</p> <p>Determines stopping mode used by the drive when a stop is initiated. Refer to the P44 - [DC Hold Time] and P45 - [DC Hold Voltage] diagrams.</p> <p>Settings:</p> <ul style="list-style-type: none"> 0 Ramp to Stop 1 Coast to Stop 2 DC Injection Braking 3 DC Injection Braking (w/Auto Shutoff) – works the same as standard DC injection braking except that it may shut off before the P44 - [DC Hold Time]. This occurs if the drive is out of current limit before the P44 - [DC Hold Time] expires. 	0/3	Numeric Value	0														
35	<p>[Base Frequency]</p> <p>Set value to rated nameplate frequency of motor. A Program Keypad Module, Remote Keypad Module or CopyCat Keypad Module is required if P35 must be changed to 50 Hz.</p>	10/240	1 Hz	60 Hz														
36	<p>[Base Voltage]</p> <p>Set value to rated nameplate voltage of motor.</p>	20/460 for 460V units & 20/230 for 230V units	1 Volt	460 for 460V units & 230 for 230V units														
37	<p>[Maximum Voltage]</p> <p>Sets the highest voltage that the drive will output. P37 - [Maximum Voltage] must be greater than or equal to P36 - [Base Voltage].</p>	20/510 for 460V units & 20/255 for 230V units	1 Volt	460 for 460V units & 230 for 230V units														

● The analog inputs to the drive (i.e. 4-20mA, 0 to +10 V, or remote potentiometer) can be scaled to P32 - [Minimum Frequency] and P33 - [Maximum Frequency] by programming P75 - [Analog Input Minimum] and P76 - [Analog Input Maximum].

Program Group

No.	Parameter Name/Description	Min./Max. Range	Units	Factory Default
38	[Boost Select] Sets the boost voltage and redefines the Volts per Hz curve. Settings 0 – 8 can provide increased torque at low frequency. Settings 9 – 12 are used to reduce energy consumption.	0/12	Numeric Value	2

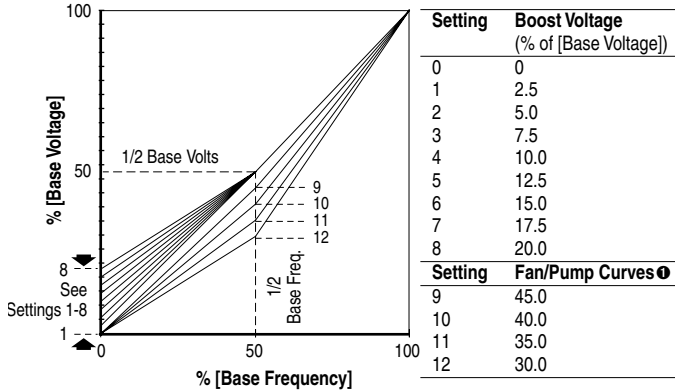

❶ Break Point Voltages in percent of [Base Voltage]

39	[Skip Frequency] Works in conjunction with P40 - [Skip Frequency Band] creating a range of frequencies at which the drive will not operate continuously.	0/240	1 Hz	240 Hz
-----------	--------------------------------------------------------------------------------------------------------------------------------------------------------------------	-------	------	--------

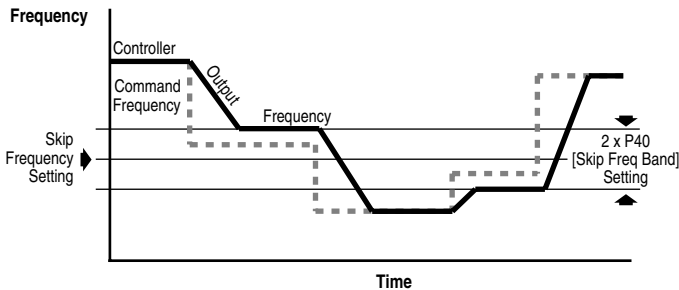

40	[Skip Frequency Band] Determines the band around the P39 - [Skip Frequency] parameter. The actual band width will be 2 times P40 - [Skip Frequency Band] - 1/2 the band above and 1/2 the band below. A value of zero will disable the skip frequency.	0/30	1 Hz	0 Hz
-----------	------------------------------------------------------------------------------------------------------------------------------------------------------------------------------------------------------------------------------------------------------------------	------	------	------

Program Group

No.	Parameter Name/Description	Min./Max. Range	Units	Factory Default
-----	----------------------------	-----------------	-------	-----------------

41 [Motor Overload Select] 0/2 Numeric Value 0

Bulletin 160 provides Class 10 overload protection. Settings 0 – 2 select the derating factor for the I²t overload function.

Setting	Derate Level
0	No Derate 10:1 speed range
1	Min. Derate 4:1 speed range, derate below 25% of base speed
2	Max. Derate 2:1 speed range, derate below 50% of base speed

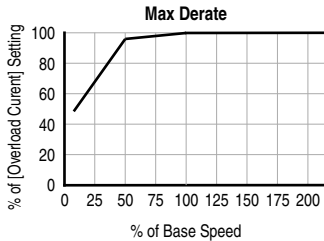
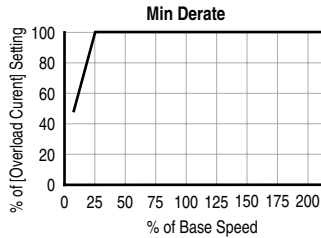
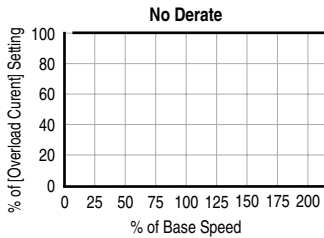

Settings
 0 = No Derating
 1 = Minimum Derating
 2 = Maximum Derating

42 [Motor Overload Current]	Set to motor nameplate Full Load Amps (FLA).	0.1/200% of Drive Rating	0.01A	115% of Drive Rating
43 [Current Limit]	Maximum output current allowed before current limiting occurs. Value set in percent of drive rated output current.	1/180% of Drive Rating	1%	150%
44 [DC Hold Time]	The time that P45 - [DC Hold Voltage] will be applied to the motor when P34 - [Stop Mode Select] is set to either "DC Injection Braking" or "Ramp to Stop."	0.0/25.0	0.1 Seconds	0.0 Seconds

Program Group

No.	Parameter Name/Description	Min./Max. Range	Units	Factory Default
45	<p>[DC Hold Voltage]</p> <p>DC Voltage level applied to the motor during braking when P34 - [Stop Mode Select] is set to either DC Injection Braking or Ramp to Stop mode.</p> <p>If the current exceeds P43 - [Current Limit] the voltage applied to the motor will be less than this setting.</p>	0/115	1 Volt	0 Volts

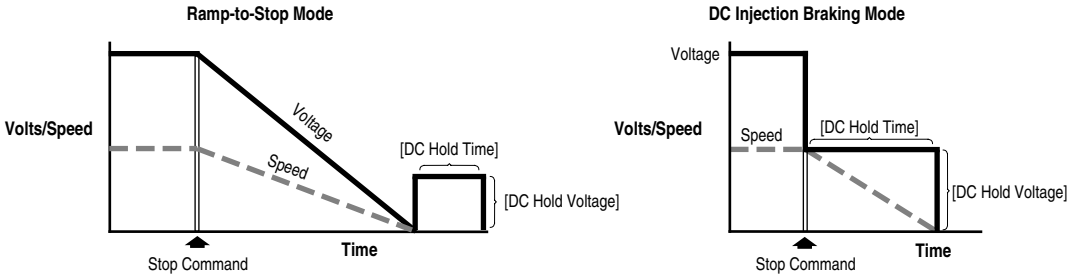

46	<p>[Input Mode]</p> <p>Configures the TB3 control inputs for various 3-wire or 2-wire control schemes. Also enables/disables the Program Keypad Module, Remote Keypad Module or CopyCat Keypad Module input control. See Chapter 2 for wiring diagrams and descriptions of settings.</p> <p>Important: The method used to activate PI control is dependent upon Firmware Version. Refer to 5-17 for PI Control Setup and Activation instructions.</p> <p>Important: This parameter cannot be programmed while the drive is running. In addition, power must be cycled or P56 - [Reset Function] must be set to 2 for the change to take effect.</p> <p>Settings:</p> <ul style="list-style-type: none"> 0 = 3-wire control ① 1 = 2-wire control ① 2 = Program Keypad Module, Remote Keypad Module, CopyCat Keypad Module, or Communication control ① 3 = Momentary Run Forward/ Run Reverse control ① 4 = 2-wire Accel/Decel control 5 = 2-wire Coast to Rest control ① 6 = 2-wire TB3 Control/Keypad or Communication control 7 = 2-wire Frequency Select control 8 = 2-wire Preset control ② 9 = 2-wire PI control ② <p>① A contact closure on TB3 Terminal 7 and 8 is required for the drive to respond to a Run command.</p> <p>② Only available in Analog Signal Follower model.</p>	0/9	Numeric Value	0
----	----------------------------------------------------------------------------------------------------------------------------------------------------------------------------------------------------------------------------------------------------------------------------------------------------------------------------------------------------------------------------------------------------------------------------------------------------------------------------------------------------------------------------------------------------------------------------------------------------------------------------------------------------------------------------------------------------------------------------------------------------------------------------------------------------------------------------------------------------------------------------------------------------------------------------------------------------------------------------------------------------------------------------------------------------------------------------------------------------------------------------------------------------------------------------------------------------------------------------------------------------------------------------------------------------------------------------------------------------------------------------------------------------------------	-----	---------------	---

Program Group

No.	Parameter Name/Description	Min./Max. Range	Units	Factory Default
-----	----------------------------	-----------------	-------	-----------------

47 [Output Configure] 0/10 Numeric Value 0
 Configures the TB3 relay output functionality.

Setting	Output Changes State When . . .
0 Drive Ready/Faulted	Energized and returns to shelf state when power is removed or a fault occurs.
1 At Frequency	Drive reaches commanded frequency.
2 Motor Running	The motor is receiving power from drive.
3 Reverse	Drive is commanded to run in the reverse direction.
4 Motor Overload	A motor overload condition exists.
5 Ramp Regulated	The ramp regulator is modifying the programmed accel/ decel times to avoid an overcurrent or overvoltage fault from occurring.
6 Above Frequency	The drive exceeds the frequency value set in P48 - [Output Threshold].
7 Above Current	Drive exceeds the value set in P48 - [Output Threshold]. Important: Value for P48 - [Output Threshold] must be entered in percent of drive rated output current.
8 Above DC Bus Voltage	Drive exceeds the DC bus voltage value set in P48 - [Output Threshold].
9 Retries Exhausted	Number of retries for P50 - [Restart Tries] is exceeded.
10 Above Power Factor Angle	Power Factor angle exceeds the value set in P48 - [Output Threshold].

48 [Output Threshold] 0/815 Numeric Value 0
 Determines the on/off point for the TB3 output relay when P47 - [Output Configure] is set to 6, 7, 8, and 10.

Setting	Ranges
6	0 to 240 Hz
7	0 to 180%
8	0 to 815 Volts
10	0 to 180°

49 [PWM Frequency] 2.0/8.0 0.1 kHz 4.0 kHz

Carrier frequency for the PWM output waveform. The chart below provides derating guidelines based on the PWM frequency setting.

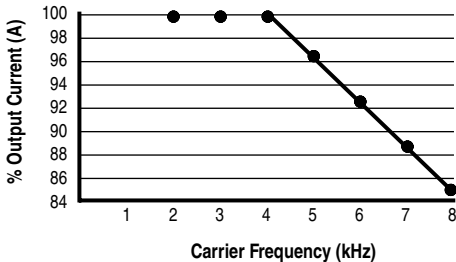

Important: Ignoring derating guidelines can cause reduced drive performance.

50 [Restart Tries] 0/9 Numeric Value 0
 Maximum number of times the drive will attempt to reset a fault. Faults 03 – 20 will automatically reset according to this parameter setting.

Program Group

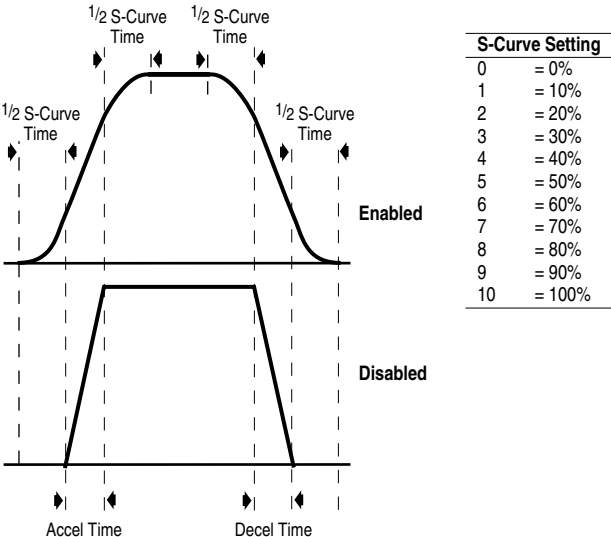
No.	Parameter Name/Description	Min./Max. Range	Units	Factory Default
51	<p>[Restart Time]</p> <p>Time between restart attempts.</p> <p>If this parameter and P50 - [Restart Tries] are both set to zero, and P46 - [Input Mode] is not set to 3, the auto fault clear feature is enabled. This feature automatically clears overvoltage, undervoltage, and overtemperature faults 1 second after the fault condition is removed.</p> <p>If this parameter is set to zero and P50 - [Restart Tries] is not zero, then the time between restart attempts is 1 second.</p>	0.0/300.0	0.1 Seconds	10.0 Seconds
52	<p>[DB Enable]</p> <p>Enables/disables external dynamic braking.</p> <p>Setting "0" = Disable. Settings 1 through 100 = % duty cycle braking.</p> <p>⚠ ATTENTION: The 160 Dynamic Brake Module is rated for 5% duty cycle. Use of this package above 5% should not be used and voids the UL rating of this device. When setting this parameter to a value above 5% duty cycle, the resistor must be sized to avoid overheating of the resistor package.</p> <p>This parameter cannot be programmed while the drive is running.</p>	0/100	Numeric Value	0
53	<p>[S-Curve]</p> <p>Enables a fixed shape S-Curve. See formula below:</p> <p>Formula: S-Curve Time = Accel or Decel Time x S-Curve Setting (in percent) ①</p> <p>① See values below.</p> <p>Example: Accel Time = 10 Seconds S-Curve Setting = 3 S-Curve Time = 10 x 0.3 = 3 Seconds</p> <p>Important: Maximum S-Curve time is 60 seconds.</p> 	0/10	Numeric Value	0

Program Group				
No.	Parameter Name/Description	Min./Max. Range	Units	Factory Default
54	<p>[Clear Fault]</p> <p>Setting this parameter to a 1 performs a fault reset. When the fault reset function is complete, the value is automatically set back to 0.</p> <p>This parameter cannot be programmed while the drive is running.</p>	0/1	Numeric Value	0
55	<p>[Memory Probe Address]</p> <p>Used by Rockwell Automation field service personnel.</p>	Numeric Value	Numeric Value	Numeric Value
56	<p>[Reset Functions]</p> <p>Drive parameters and their associated defaults are reset according to the following descriptions:</p> <p>Settings:</p> <p>0 Idle State</p> <p>1 Reset defaults (restores all parameter settings to factory defaults).</p> <p>2 Update Input Mode (restores the drive to most recent programmed P46 - [Input Mode] setting).</p> <p>After the reset/update function is complete, this parameter will set itself back to a "0." This parameter cannot be programmed while the drive is running.</p> <p>Important: For setting 1 only, an F48 - Reprogram Fault will occur and must be cleared by cycling the Stop input to the drive. P46 - [Input Mode] factory defaults to 3-wire control. If using keypad control, change parameter setting back to a 2 to regain program keypad control, cycle power or use P56 Setting 2 again.</p>	0/2	Numeric Value	0
57	<p>[Program Lock]</p> <p>When set to 1, all parameters will be protected against change by unauthorized personnel.</p>	0/1	Numeric Value	0
58	<p>[Internal Frequency]</p> <p>When P59 - [Frequency Select] is set to a 1, this parameter will provide the drive frequency command. This parameter will change the frequency command in "Real time" using the up/down arrow keys. Maximum value is set in P33 - [Maximum Frequency].</p> <p>Important: Follow normal programming procedures. Once the desired command frequency is reached, the Enter key must be pressed to store this value to EEPROM memory. If the ESC key is used before the Enter key, the frequency will return to the original value following the normal accel/decel curve.</p>	0.0/240.0	0.1 Hz	60.0 Hz
59	<p>[Frequency Select]</p> <p>Selects the source of the frequency command for the drive.</p> <p>Settings: 0 = External frequency command from the Control Terminal Block (TB3)</p> <p>1 = Internal frequency command from P58 - [Internal Frequency].</p>	0/1	Numeric Value	0
60	<p>[Zero Offset]</p> <p>Used to add or subtract any system offset to the analog input. See P16 - [Analog Input] for additional information.</p> <p>Important: This parameter cannot be programmed while the drive is running.</p>	-50.0/+ 50.0	Numeric Value	0%



This parameter applies only to the Analog Signal Follower model.

Program Group				
No.	Parameter Name/Description	Min./Max. Range	Units	Factory Default

[Preset Frequency 0-7]

0.0/240.0

0.1 Hz

See Table

The programmed value sets the frequency that the drive outputs when selected. Refer to Chapter 2, Figure 2.21 for the Preset Speed model control wiring diagram.

	<i>Preset Speed Model Only</i>					<i>Signal Follower Model Only (Input Mode 8)</i>		Accel	Decel
	Preset Freq.	Default	TB3-4 (SW3)	TB3-2 (SW2)	TB3-1 (SW1)	TB3-8 (SW2)	TB3-2 (SW1)		
61	Preset 0	3.0 Hz	0	0	0	0	0	P30 [Accel Time 1]	P31 [Decel Time 1]
62	Preset 1	20.0 Hz	0	0	1	0	1		
63	Preset 2	30.0 Hz	0	1	0	N/A	N/A		
64	Preset 3	40.0 Hz	0	1	1	N/A	N/A		
65	Preset 4	45.0 Hz	1	0	0	1	0	P69 [Accel Time 2]	P70 [Decel Time 2]
66	Preset 5	50.0 Hz	1	0	1	1	1		
67	Preset 6	55.0 Hz	1	1	0	N/A	N/A		
68	Preset 7	60.0 Hz	1	1	1	N/A	N/A		

When using P46 - [Input Mode] setting 4, the Accel and Decel times are selected by providing an input to TB3-8. See Chapter 2, Figure 2.12 for additional information.

69	[Accel Time 2]	0.0/600.0	0.1 Sec.	20.0 Seconds
-----------	-----------------------	-----------	----------	--------------

Time for the drive to ramp from 0.0 Hz to P33 - [Maximum Frequency]. The rate is linear for any increase in command frequency unless P53 - [S-Curve] is set to a value other than 0. Setting this to 0.0 gives 0.1 seconds acceleration with the initial current limit turned off. This allows quicker acceleration times for low inertia systems. For medium to high inertia systems, the minimum value should be 0.1.

70	[Decel Time 2]	/600.0	0.1 Sec.	20.0 Seconds
-----------	-----------------------	--------	----------	--------------

Time for the drive to ramp from P33 - [Maximum Frequency] to 0.0 Hz. The rate is linear for any decrease in command frequency unless P53 - [S-Curve] is set to a value other than 0.

Minimum deceleration time must be set based on the applied motor size. To guard against premature drive failure, do not set P31 - [Decel Time 1] or P70 - [Decel Time 2] below the minimum value listed in the table below.

230 and 460V Motor Sizes	Minimum Deceleration Settings
4.0 kW (5 HP)	0.7 seconds
2.2 kW (3 HP)	0.6 seconds
1.5 kW (2 HP)	0.2 seconds
0.75 kW (1 HP)	0.1 seconds
0.55 kW (0.75 HP)	0.1 seconds
0.37 kW (0.5 HP)	0.1 seconds

This parameter applies only to the Preset Speed model.

Program Group				
No.	Parameter Name/Description	Min./Max. Range	Units	Factory Default
71	<p>[IR Compensation]</p> <p>The programmed value adds a voltage to the output based on the torque current. An additional 31 volts (150%) is added to 460 volt units to compensate for stator resistance. 15.5 volts (150%) is added for 230 volt units. If the drive trips on an F07 - Motor Overload fault, or has trouble accelerating to commanded speed, this value should be reduced. A setting of 0% disables this function.</p>	0/150	1%	50%
72	<p>[Slip Compensation]</p> <p>This parameter compensates for the inherent slip in an induction motor. A frequency is added to the commanded output frequency based on torque current. If motor shaft speed decreases significantly under heavy loads then this value should be increased. A setting of 0.0 Hz disables the function. This parameter along with P83 - [PI Process Reference] also activates PI control in drives using Firmware Version FRN 7.06. See page 5-17 for PI Control Setup and Activation instructions.</p> <p> ATTENTION: Hazard of personal injury or equipment damage exists due to unpredictable changes in motor speed. Do not use P72 - [Slip Compensation] and P83 - [Process Reference] to disable PI control while the drive is running. Disable PI control only when the drive is stopped.</p>	0.0/5.0	0.1 Hz	2.0 Hz
73	<p>[Reverse Disable]</p> <p>When this parameter is set to a 1, reverse is disabled. The reverse command may come from the analog input, TB3-5, the keypad or a serial command. With a negative analog input and reverse disabled, the frequency command will be zero in bipolar mode and minimum frequency in unipolar mode. All digital reverse inputs including two-wire Run Reverse will be ignored with reverse disabled.</p> <p>Important: This parameter cannot be programmed while the drive is running.</p>	0/1	Numeric value	0
74	<p>[Analog Select]</p> <p>Settings: 0 = unipolar analog input 0 to +10V 1 = bipolar analog input -10 to +10V</p> <p>Important: With this parameter set to bipolar (setting 1), the parameter settings for P75 - [Analog Input Minimum] and P32 - [Minimum Frequency] are ignored. In addition, all other reverse inputs (Program Keypad Module, Remote Keypad Module, CopyCat Keypad Module, TB3-5 control terminal block, or serial communication module) are ignored with the exception of when P46 - [Input Mode] is programmed to setting 7. (This applies to drives with firmware version FRN 7.03 and later.) When P46 - [Input Mode] setting 7 is active, and TB3-8 is closed, the frequency source is P58 - [Internal Frequency] and the direction will be commanded from the control terminal block (either terminal TB3-5 or TB3-6).</p> <p>Important: This parameter cannot be programmed while the drive is running.</p>	0/1	Numeric value	0



This parameter applies only to the Analog Signal Follower model.

Program Group				
No.	Parameter Name/Description	Min./Max. Range	Units	Factory Default
75	<p>[Analog Input Minimum]</p> <p>Important: Do not adjust this parameter until setting P60 - [Zero Offset]. Sets the percent of analog input used to represent P32 - [Minimum Frequency]. If the minimum analog input equals minimum frequency, no action is needed. If it is desired to adjust the analog input to equal P32 - [Minimum Frequency], use P16 - [Analog Input] to adjust the analog input to the desired level using P60 and then enter this value into P75.</p> <p>Analog inversion can be accomplished by setting this value larger than P76.</p> <p>Important: This parameter cannot be programmed while the drive is running.</p>	0.0/150.0	0.1%	0.0%
76	<p>[Analog Input Maximum]</p> <p>Important: Do not adjust this parameter until setting P60 - [Zero Offset]. Sets the percent of analog input used to represent P33 - [Maximum Frequency]. If the maximum analog input equals maximum frequency, no action is needed. If it is desired to adjust the analog input to equal P33 - [Maximum Frequency], use P16 - [Analog Input] to adjust the analog input to the desired level using P60 and then enter this value into P76.</p> <p>Analog inversion can be accomplished by setting this value smaller than P75.</p> <p>Important: This parameter cannot be programmed while the drive is running.</p>	0.0/150.0	0.1%	100.0%
78	<p>[Compensation]</p> <p>Settings:</p> <p>0 No compensation.</p> <p>1 Some drive/motor combinations have inherent instabilities which are exhibited as non-sinusoidal motor currents. This setting attempts to correct this condition.</p> <p>2 Some motor/load combinations have mechanical resonances which can be excited by the drive current regulator. This setting slows down the current regulator response and attempts to correct this condition.</p>	0 to 2	Numeric value	0
79	<p>[Software Current Trip]</p> <p>This provides a software instantaneous current trip similar to the 300% hardware current trip. This value is the percent above the P43 - [Current Limit] at which the drive trips immediately. A setting of zero disables the Software Current Trip.</p>	0/50%	1%	0%
80	<p>[Stall Fault Time]</p> <p>This selects the amount of time the drive must be in a stall condition before it causes a stall fault.</p> <p>0 = Normal stall time, approximately 60 seconds</p> <p>1 = 2 times normal stall time</p> <p>2 = 4 times normal stall time</p> <p>3 = 6 times normal stall time</p> <p>4 = 8 times normal stall time</p> <p>5 = Stall fault disabled</p> <p> ATTENTION: Continuous operation at high currents caused by a stall can cause motor damage.</p>	0/5	Numeric Value	0



ATTENTION: Continuous operation at high currents caused by a stall can cause motor damage.



This parameter applies only to the Analog Signal Follower model.

Program Group				
No.	Parameter Name/Description	Min./Max. Range	Units	Factory Default
81	<p>[PI Proportional Gain]</p> <p>Proportional gain used by the PI regulator. This parameter is scaled so that when it is set to 1.0, the process response is 1 Hz when the process error is 1%. The correct value for this parameter depends on the dynamics of the process being controlled, as well as the desired response. This parameter is active when P46 - [Input Mode] setting 9 is used.</p>	0/10.00	Numeric Value	0.01
82	<p>[PI Integral Gain]</p> <p>Integral Gain used by the PI regulator. This parameter is scaled so that when it is set to 1.0, the process response is 10 Hz/sec when the process error is 1%. The correct value for this parameter depends on the dynamics of the process being controlled, as well as the desired response. This parameter is active when P46 - [Input Mode] setting 9 is used.</p>	0/10.00	Numeric Value	0.01
83	<p>[PI Process Reference]</p> <p>The PI control will regulate to this set point value. It represents a percentage of the analog input. This parameter is active when P46 - [Input Mode] setting 9 is used. This parameter along with P72 - [Slip Compensation] also activates PI control in drives using Firmware Version FRN 7.06. See page 5-17 for PI Control Setup and Activation instructions.</p> <p>⚠ ATTENTION: Hazard of personal injury or equipment damage exists due to unpredictable changes in motor speed. Do not use P72 - [Slip Compensation] and P83 - [Process Reference] to disable PI control while the drive is running. Disable PI control only when the drive is stopped.</p>	0/100.0%	0.1%	0.0%
84	<p>[PI Dead Band]</p> <p>The PI control will ignore errors less than this value. This parameter is active when P46 - [Input Mode] setting 9 is used.</p>	0/10.0%	0.1%	0.0%

This parameter applies only to the Analog Signal Follower model.

PI Control Block Diagram

Figure 5.1

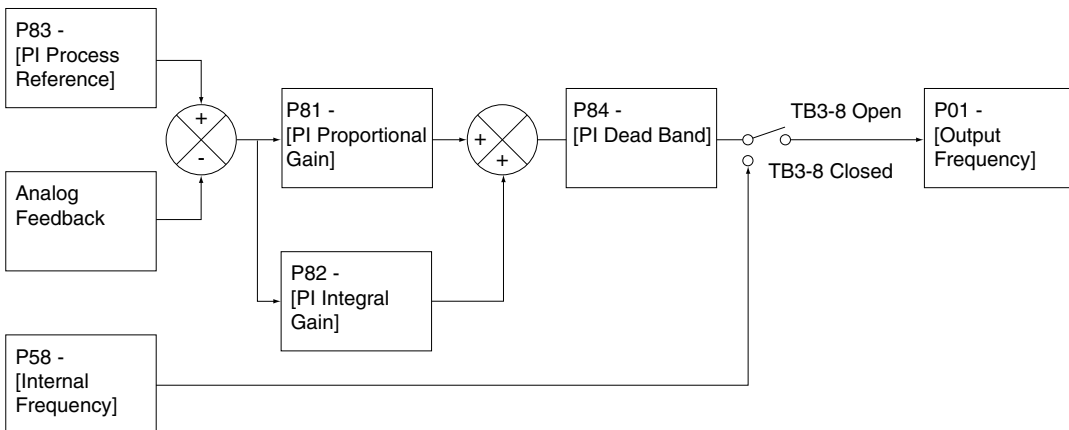

PI Control Setup and Activation

The Analog Signal Follower model provides for closed loop process control (PI control) where PI regulator output is used to drive the process to a desired set point.

Wire For PI Control

1. Connect input and output power to the drive.
Follow the instructions provided in Section 2, *Installation and Wiring*.
2. Connect control wiring (see Chapter 2, Figure 2.17). A contact closure on terminals 6 and 7 is required for the drive to respond to a Start/Run command.
3. Select an external frequency command source. See Table 5.B.
4. Connect feedback device to TB3-2 and TB3-3 for 0 – 10V feedback or to TB3-3 and TB3-4 for 4 – 20 mA feedback.
5. Verify polarity of feedback. That is, increasing feedback signal requires increasing output frequency.

Program for PI Control

1. Set P56 - [Reset Functions] to 1 to reset the drive to defaults.
An F48 - Reprogram Fault will occur which must be cleared by cycling the Stop input to the drive.
2. Users of Firmware Version 7.06: Set P46 - [Input Mode] to the desired setting.
Users of Firmware Version 7.05 and earlier: Set P46 - [Input Mode] to 9.

Table 5.B describes how to reference the external frequency command source for each P46 - [Input Mode] setting.

Parameter 46 Settings and Frequency Source Selection Table 5.B

P46 Setting	Reference External Frequency Command Source	Firmware Version
0	Set P59 - [Frequency Select] to 0 (Factory Default)	FRN 7.06 only
1	Set P59 - [Frequency Select] to 0 (Factory Default)	FRN 7.06 only
2	Set P59 - [Frequency Select] to 0 (Factory Default)	FRN 7.06 only
3	Set P59 - [Frequency Select] to 0 (Factory Default)	FRN 7.06 only
4	Set P59 - [Frequency Select] to 0 (Factory Default)	FRN 7.06 only
5	Set P59 - [Frequency Select] to 0 (Factory Default)	FRN 7.06 only
6	Set P59 - [Frequency Select] to 0 (Factory Default)	FRN 7.06 only
7	Open the contact at TB3-8	FRN 7.06 only
8	This setting is not used with PI control.	
9	Open the contact at TB3-8	FRN 7.06 or earlier

3. Cycle power or set P56 - [Reset Functions] to 2 for the change made at Step 2 to take effect.
4. Set P72 - [Slip Compensation] to 0.

5. Use P75 - [Analog Input Minimum] and P76 - [Analog Input Maximum] to scale feedback to the process operating range. This may also be used to invert the feedback so that increasing feedback signal produces decreasing output frequency.
6. Set P83 - [PI Process Reference] to 20 as an initial setting. This establishes the set point as 20% of the maximum analog input. (This setting must be greater than zero to activate PI control in Firmware Version FRN 7.06 except when using input mode 9.)
7. Connect TB3-8 with TB3-7. This will disable PI control and force the output frequency to the P58 - [Internal Frequency] setting.
8. Connect TB3-6 with TB3-7 to start the drive. Verify motor operation and direction.
9. Remove the connection between TB3-8 from TB3-7. This will place the drive into PI control mode when using input modes 7 and 9.



ATTENTION: Hazard of personal injury or equipment damage exists due to unpredictable changes in motor speed. Do not use P72 - [Slip Compensation] and P83 - [Process Reference] to disable PI control while the drive is running. Disable PI control only when the drive is stopped.

Tune the PI Loop

Parameters P81 - [PI Proportional Gain] and P82 - [PI Integral Gain] are used to set how the drive will respond to errors (fluctuations) in feedback.

- P81 - [PI Proportional Gain] corrects output frequency based on the magnitude of the error.
 - P82 - [PI Integral Gain] corrects output frequency based on the length of time an error has been present.
1. Set P82 - [PI Integral Gain] to zero and P81 - [PI Proportional Gain] to some low value.
 2. Apply a step function command via P83 - [PI Process Reference] and monitor the output response.
 3. Increase P81 - [PI Proportional Gain] until the response of the output is acceptably fast or the output becomes too noisy.
 4. Reduce P81 - [PI Proportional Gain] back to the highest value at which the response is still clean.
 5. Set P82 - [PI Integral Gain] to a low value.
 6. Apply a step function command and monitor the output response.
 7. Increase P82 - [PI Integral Gain] until the response is acceptably fast without overshoot.

Important: If either the value of P81 or P82 is set too high, drive output will oscillate around the set point entered in P83 - [PI Process Reference] due to continually changing loads in the application. Use P84 - [Dead Band] to limit the effects of this oscillation by blocking a frequency count to either side of the set point frequency.

Common Problems with PI Control

1. Drive direction is incorrectly set for PI control.
Ensure that the drive is operating with the clockwise direction indicator illuminated.
2. Drive oscillates between 0 and 3 Hz.
 - Check direction and polarity of analog input signal.
 - Ensure that the drive is operating with the clockwise direction indicator illuminated.
 - Ensure the +10V DC wire is connected to TB3-2 and that the common is connected to TB3-3.
 - Check that parameters P81 - [PI Proportional Gain] and P82 - [PI Integral Gain] are set to a value other than 0.00.
3. Drive accelerates too quickly resulting in an F05 - OverVoltage Fault.
 - Lower P81 - [PI Proportional Gain] below its current value.
 - Lower P82 - [PI Integral Gain] below its current value.
 - Raise P31 - [Decel Time 1] above its current value.
 - Raise P30 - [Accel Time 1] above its current value.
 - Evaluate the need for a dynamic brake for the application.
4. Drive will only run off the internal frequency or does not control with the PI process loop.
 - Check that P46 - [Input Mode] is set to 9.
 - Ensure that power was cycled for one minute after changing the P46 setting.
 - Ensure that there is not a connection between TB3-7 and 8.
5. Nothing works properly.
 - Set P56 - [Reset Functions] to 1 and press the Enter key.
 - Press the Stop button to clear the F48 - Reprogram Fault.
 - Cycle power to the drive.
 - Confirm that wiring is correct.
 - Reapply power and program according to this procedure.
6. PI does not function with DeviceNet.
 - Firmware Version 7.05 and earlier only allows one P46 - [Input Mode] setting to be active at one time (settings 2 or 6 for DeviceNet or setting 9 for PI).
 - It is possible for users of Firmware Version 7.05 and earlier to set up PI control via an external processor, such as a SLC500. Consult your processor manual for specific instructions.

End of Chapter

Troubleshooting

Fault Information

This chapter provides information to guide you in troubleshooting the drive. Included is a list and description of drive faults and problems that may occur.

Program Keypad Module Fault Display

Figure 6.1

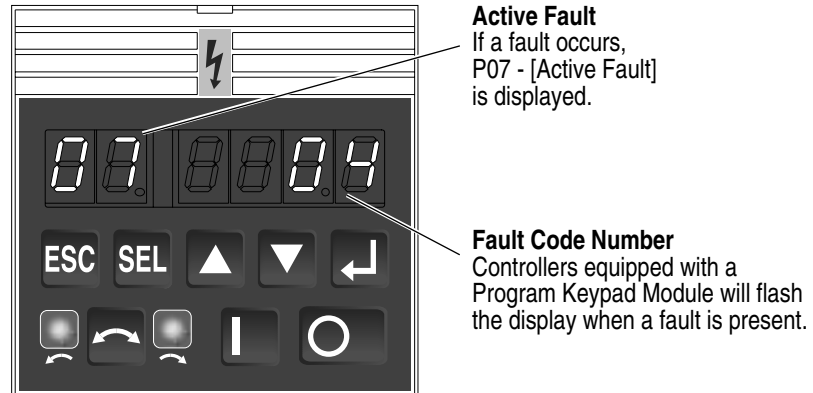

Ready/Fault Indicating Panel

Figure 6.2

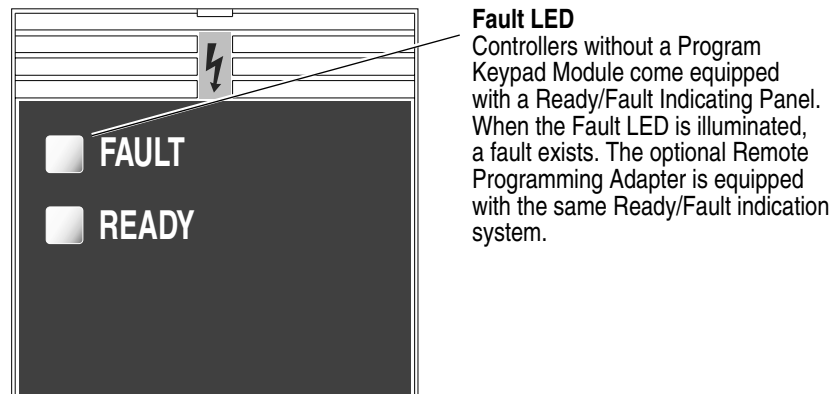

How to Clear a Fault

When a fault occurs, the cause must be corrected before the fault can be cleared. After corrective action has been taken, any of the following actions will clear the fault.

- Press the Program Keypad Module's Stop button.
- Disconnect power to the drive, wait one minute, reapply power.
- Cycle the input signal at TB3-8 to the drive.
- Set P54 - [Clear Fault] to 1.

Bulletin 160 Fault Descriptions

Table 6.A

Fault No.	Fault Name	Fault Description	Corrective Action
03	Power Loss Fault	The DC Bus voltage remains below 85% nominal on power up for longer than 5 seconds.	Monitor the incoming AC line for low voltage or line power interruptions.
04 ¹	UnderVoltage Fault	The DC Bus voltage fell below the minimum rated voltage. For 200-240V AC input drives, the undervoltage trip occurs at a bus voltage of 210VDC (equivalent to a 150VAC incoming line voltage). For 380-460VAC rated drives, the undervoltage trip occurs at a bus voltage of 390VDC (equivalent to a 275VAC incoming line voltage).	Monitor the incoming AC line for low voltage or line power interruptions.
05 ¹	OverVoltage Fault	The maximum DC Bus voltage has been exceeded. For 200-240V AC input drives, the overvoltage trip occurs at a bus voltage of 400VDC (equivalent to a 290V AC incoming line voltage). For 380-460V AC input drives, the overvoltage trip occurs at a bus voltage of 800VDC (equivalent to a 575V AC incoming line voltage).	Motor regeneration has caused a bus overvoltage. Monitor the incoming AC line for excessive voltage. Extend the decel time or install a dynamic brake module or external capacitor module (See Appendix A).
06 ¹	Motor Stall Fault	The motor has stalled due to an excessive motor load.	A longer acceleration time or a reduced load is required.
07 ¹	Motor Overload Fault	An internal electronic overload trip has occurred. An excessive motor load exists.	Reduce the motor load until the drive output current does not exceed the current set by P42 - [Motor Overload Current]. Reduce P38 - [Boost Select].
08 ¹	Over Temperature Fault	Excessive heat has been detected.	Clear blocked or dirty heat sink fins. Check ambient temperature. Check for a blocked or non-operating fan.
11	Operator Fault	The keypad has been removed while the drive is powered.	Clear the fault. Do not remove the keypad under power.
12 ¹	Overcurrent Fault	An overcurrent has been detected in the hardware trip circuit.	Check for a short circuit at the drive output or for excessive load conditions at the motor.
13 ¹	Software Over Current Fault	Motor current exceeded value set in parameter 79.	A longer acceleration time, reduced load, or removal of motor shaft blockage is required.
20 ¹	Drive Overload Fault	An internal electronic overload trip has occurred. The drive is over heating.	Clear blocked or dirty heat sink fins. Check ambient temperature. Check for blocked or non-operating fan. Reduce motor load current.
32	EEPROM Fault	The EEPROM has invalid data.	Reset EEPROM using P56 - [Reset Functions] — Set to 1 and cycle power.
33	Max Retries Fault	The drive failed to reset within the number of retries set in P50 - [Restart Tries].	Repair the system fault.
36	Incompatible Fault	Incompatible communication module installed.	Verify compatibility of communication module.
38	Phase U Fault	A phase to ground fault has been detected between the drive and the motor in phase U.	Check the wiring between the drive and the motor. Check the motor for a grounded phase. Check that ground is not connected to U.
39	Phase V Fault	A phase to ground fault has been detected between the drive and the motor in phase V.	Check the wiring between the drive and the motor. Check the motor for a grounded phase.
40	Phase W Fault	A phase to ground fault has been detected between the drive and the motor in phase W.	Check the wiring between the drive and the motor. Check the motor for a grounded phase.
41	UV Short Fault	Excessive current has been detected between these two drive output terminals.	Check the motor and external wiring to the drive output terminals for a shorted condition.
42	UW Short Fault	Excessive current has been detected between these two drive output terminals.	Check the motor and external wiring to the drive output terminals for a shorted condition.
43	VW Short Fault	Excessive current has been detected between these two drive output terminals.	Check the motor and external wiring to the drive output terminals for a shorted condition.
46	Intermittent Phase Fault	An external short occurred while running diagnostics.	Check wiring between the drive and the motor. Check for more than one shorted output.
48	Reprogram Fault	Occurs when the drive parameters are reset to default.	Clear the fault.

¹ These faults have an auto reset feature. This feature automatically clears overvoltage, undervoltage, and overtemperature faults 1 second after the fault condition is removed. Refer to P51 - [Restart Time].

Possible Problems and Corrective Actions

Table 6.B

Problem	Corrective Action
The motor does not start — No output voltage to the motor.	<ol style="list-style-type: none"> 1. Check the power circuit. <ul style="list-style-type: none"> • Check the supply voltage. • Check all fuses and disconnects. 2. Check the motor. <ul style="list-style-type: none"> • Verify that the motor is connected properly. 3. Check the control input signals. <ul style="list-style-type: none"> • Verify that the Start signal is present. • Verify that the contact closure signal is present at TB3-8. • Verify that either the Run Forward or Run Reverse signal is active, but not both. 4. Check P46 - [Input Mode]. <ul style="list-style-type: none"> • If P46 - [Input Mode] is set to 2, only the program keypad module Start button will start the motor. 5. Cycle power or use P56 - [Reset Functions] if you changed P46 - [Input Mode].
The drive is started but the motor is not rotating. P01 - [Output Frequency] displays 0.0.	<ol style="list-style-type: none"> 1. Check the motor. <ul style="list-style-type: none"> • Verify that the motor is connected properly. 2. Check the frequency source P06 - [Frequency Command]. <ul style="list-style-type: none"> • Verify that a frequency signal is present at terminal block TB3 — Either a -10 to +10V signal or a 4-20 mA signal. • Verify that the Preset Frequencies are set properly. 3. Check the control input signals. <ul style="list-style-type: none"> • Verify that SW1, SW2 and SW3 are correct. (Refer to the chart in Chapter 5.) 4. Check the following parameter settings. <ul style="list-style-type: none"> • Verify that P59 - [Frequency Select] is showing the desired frequency source. • Verify that P58 - [Internal Frequency] is set to the desired frequency. 5. Cycle power or use P56 - [Reset Functions] if you changed P46 - [Input Mode].
The motor is not accelerating properly.	<ol style="list-style-type: none"> 1. Check the motor. <ul style="list-style-type: none"> • Verify that the motor is connected properly. • Verify that no mechanical problems exist. 2. Check the following parameter settings. <ul style="list-style-type: none"> • Verify that P30 - [Accel Time 1] or P69 - [Accel Time 2] — whichever is currently used — is set properly. • Verify that P43 - [Current Limit] is set properly. • Verify that P38 - [Boost Volts] is set properly.
Drive will not operate in the run/forward or run reverse modes.	<ol style="list-style-type: none"> 1. Verify that P46 - [Input Mode] is set to 1. 2. Verify that neither P73 - [Reverse Disable] nor P74 - [Analog Select] is set to 1. 3. Verify that the power has been cycled for 1 and 2 to take effect. 4. Verify that both the Run Forward and Run Reverse switches are not closed simultaneously. 5. Cycle power or use P56 - [Reset Functions] if you changed P46 - [Input Mode].
Display is dark.	<ol style="list-style-type: none"> 1. Verify that the module is firmly seated. 2. Remove module and inspect connector pins. If pins are not damaged, reinstall and firmly seat the module.

Block Diagram of Bulletin 160 Analog Signal Follower

Figure 6.3

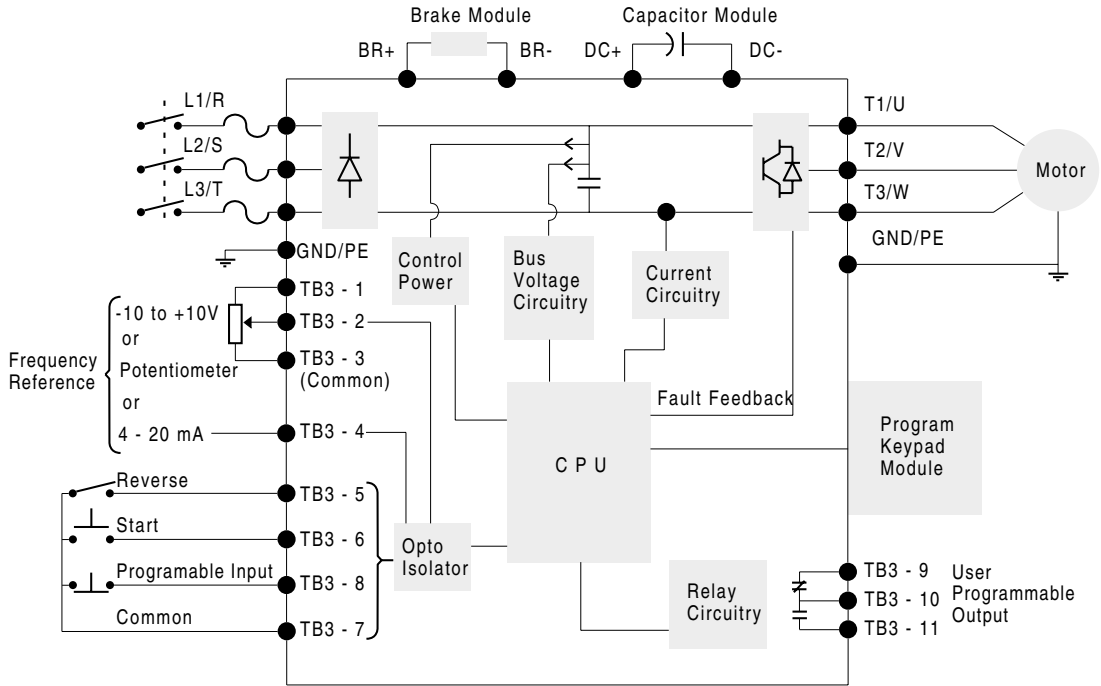

Specifications

Tables A.A and A.B contain information that is unique to each Bulletin 160 Drive rating. Table A.C contains information that applies to all drive ratings.

200-240VAC – 1-Phase & 3-Phase Input Drive Ratings

Table A.1

Drive Catalog Number						
1-Phase Input	160S-AA02	160S-AA03	160S-AA04	160S-AA08	—	—
3-Phase Input	160-AA02	160-AA03	160-AA04	160-AA08	160-AA12	160-AA18
Output Ratings						
3-Phase Motor Rating — kW (HP)	0.37 (1/2)	0.55 (3/4)	0.75 (1)	1.5 (2)	2.2 (3)	3.7 (5)
Maximum Output Amps	2.3	3.0	4.5	8.0	12.0	18.0
Power Dissipation — Watts	20	25	35	74	107	137
Input Ratings						
Input Voltage, Frequency	200/240VAC, 1-Phase and 3-Phase, 50/60 Hz					
Operational Input Voltage Range	180-265VAC					
Input kVA	1.1	1.4	2.2	3.7	5.7	8.4
1-Phase Input Current ❶	4.8	6.2	9.4	16.3	—	—
3-Phase Input Current ❶	2.8	3.6	5.4	9.4	14.2	21.1
Environmental Specifications						
Cooling Method	Convection Cooled		Fan Cooled			
Dynamic Braking Torque ❷						
With External Dynamic Brake Module	—	—	200	150	115	100
Without External Dynamic Brake Module	100	100	100	50	50	20

380-460VAC – 3-Phase Input Drive Ratings

Table A.2



Drive Catalog Number						
3-Phase Input	160-BA01	160-BA02	160-BA03	160-BA04	160-BA06	160-BA10
Output Ratings						
3-Phase Motor Rating — kW (HP)	0.37 (1/2)	0.55 (3/4)	0.75 (1)	1.5 (2)	2.2 (3)	3.7 (5)
Maximum Output Amps	1.2	1.7	2.3	4.0	6.0	10.5
Power Dissipation — Watts	25	30	37	50	77	120
Input Ratings						
Input Voltage, Frequency	380/460VAC, 3-Phase, 50/60 Hz					
Operational Input Voltage Range	340-506VAC					
Input kVA	1.1	1.6	2.2	3.7	5.6	9.7
Input Current ❶	1.4	2.0	2.8	4.6	7.0	12.2
Environmental Specifications						
Cooling Method	Convection Cooled		Fan Cooled			
Dynamic Braking Torque ❷						
With External Dynamic Brake Module	—	—	200	150	115	100
Without External Dynamic Brake Module	100	100	100	50	50	20

❶ Input current ratings are calculated based on a nominal input voltage of 230V and 460V respectively.

❷ Estimated – Actual value depends upon motor characteristics.

All Drive Ratings

Table A.3

Input/Output Ratings	
Output Voltage	Adjustable from 0 to Input Voltage
Output Frequency	Programmable from 0 to 240 Hz
Efficiency	97.5% Typical
Transient Protection	Standard 6 kV
Environmental Specifications	
Enclosure	IP20
Ambient Temperature	0°C to 50°C
Storage Temperature	-40°C to 85°C
Relative Humidity	0 to 95% Non-Condensing
Vibration	1.0 G Operational — 2.5 G Non-Operational
Shock	15 G Operational — 30 G Non-Operational
Altitude	1,000 m (3,300 ft) without Derating
Control Inputs	
Control Input Type	<p>Dry Contact Inputs — Drive has an internal 12V power supply that provides 10 mA typical current flow.</p> <p>Alternate Inputs — Accepts open collector/solid state inputs (sinking into the drive) with maximum leakage current of 50 μA.</p> <p>24V Inputs — An optional 24V DC interface module allows use of 24V DC sinking inputs (see).</p>
Start, Stop, Fwd/Rev	Configurable Inputs for Two- or Three-Wire Control
SW1, SW2, SW3 <i>Preset Speed Model Only</i>	Configurable Inputs for Control of 8 Preset Speeds and 2 Accel/Decel Times
Programmable Input	<p>TB3-8 Can Be Configured to Select:</p> <ul style="list-style-type: none"> • Accel/Decel Times • External Coast to Rest • TB3 Control/Keypad or Communication Control • Frequency Select • Preset Speed ①
Approvals and Standards Compliance	
Approvals	    <p>EMC Directive 89/336 LV: EN 50178, EN 60204 EMC: EN 61800-3, EN 50081-1, EN 50082-2</p>
Designed to Meet These Standards	FCC Class A ② and B ②, IEC 146-1-1, VDE 0871 and VDE 0875
Control Inputs — Analog Signal Follower Only	
External Speed Potentiometer	1K to 10K Ohms, 2 Watts Minimum
4 – 20 mA Analog Input	250 Ohms Input Impedance
-10 to +10VDC Analog Input	100K Ohms Input Impedance
Control Output	
Programmable Output (Form C Relay Contact)	Resistive Rating: 0.4A at 125V AC — 0.2A at 230V AC — 2A at 30V DC Inductive Rating: 0.2A at 125V AC — 0.1A at 230V AC — 1A at 30V DC

① Analog Signal Follower only.

② With external components.

Control Features	
PWM Algorithm	Sine Weighted PWM with Harmonic Compensation
Switching Device	IGBT
V/Hz Ratio	Programmable
Carrier Frequency	Adjustable from 2 to 8kHz in 100 Hz Increments (Factory Default is 4kHz)
DC Boost	Adjustable — Select from a Family of Boost Curves
Current Limiting	Software Controlled, Coordinated for Drive and Motor Protection — Programmable from 1 to 180% of Drive Output Current
Motor Protection	I^2t Overload Protection — 150% for 60 Seconds, 200% for 30 Seconds
Overload Pattern #0	Flat Response Over Speed Range (No Speed Compensation)
Overload Pattern #1	Speed Compensation Below 25% of Base Speed
Overload Pattern #2	Speed Compensation Below 100% of Base Speed
Accel/Decel Time(s)	0.1 to 600 Seconds
S-Curve Accel/Decel Time(s)	0 to 100% of Accel/Decel Time — Not to Exceed 60 Seconds
Stopping Modes	4 Programmable Modes: Ramp to Stop — 0.1 to 600 Seconds Coast to Stop — Stops All PWM Output DC Injection Braking — Applies DC Voltage to the Motor for 0 to 25 Seconds DC Injection Braking with Auto Stop

Protective Features	
Overcurrent	Programmable limit, 200% of Hardware Limit, 300% of Instantaneous Fault
Excessive Temperature	Embedded Temperature Sensor Trips if Heatsink Temperature Exceeds 95°C
Over/Under Voltage	DC bus voltage is monitored for safe operation. <ul style="list-style-type: none"> • For 200-240V AC input drives, the overvoltage trip occurs at a bus voltage of 400V DC (equivalent to a 290V AC incoming line voltage). • For 380-460V AC input drives, the overvoltage trip occurs at a bus voltage of 800V DC (equivalent to a 575V AC incoming line voltage). • For 200-240V AC input drives, the undervoltage trip occurs at a bus voltage of 210V DC (equivalent to a 150V AC incoming line voltage). • For 380-460V AC input drives, the undervoltage trip occurs at a bus voltage of 390V DC (equivalent to a 275V AC incoming line voltage).
Control Ride Through	Minimum Ride Through is 0.5 Seconds — Typical Value is 2 Seconds
Ground Short	Any Output Phase to Ground Short
Faultless Ride Through	100 Milliseconds
Output Short Circuit	Any Output Phase to Phase Short

Programming	
Programmer	Optional — Removable Program Keypad Module
Display Type	6 Character LED — Two Digit Parameter Number and Four Digit Value
Keypad Controls	Speed, Run, Stop and Direction

End of Chapter

Accessories and Dimensions

Accessories for All Drive Ratings

Drive Ratings			Dynamic Brake Module	3% Line Reactors Open Style	Line Filters ❶		Fan Replacement Kit ❷	Capacitor Module
Input Voltage	kW	HP	Catalog No.	Catalog No. ❸	Catalog No. ❹	Catalog No. ❺	Catalog No.	Catalog No.
200-240VAC 50/60 Hz 1-Phase	0.37	1/2	—	—	160S-LFA1	160S-RFA-9-A	—	160-CMA1
	0.55	3/4	—	—	160S-LFA1	160S-RFA-9-A	—	160-CMA1
	0.75	1	160-BMA1	—	160S-LFA1	160S-RFA-9-A	160-FRK2	160-CMA1
	1.5	2	160-BMA2	—	160S-LFA1	160S-RFA-16-B	160-FRK3	160-CMA1
200-230VAC 50/60 Hz 3-Phase	0.37	1/2	—	1321-3R4-B	160-LFA1	160-RFB-5-A	—	160-CMA1
	0.55	3/4	—	1321-3R4-A	160-LFA1	160-RFB-5-A	—	160-CMA1
	0.75	1	160-BMA1	1321-3R4-A	160-LFA1	160-RFB-5-A	160-FRK2	160-CMA1
	1.5	2	160-BMA2	1321-3R8-A	160-LFA1	160-RFB-14-A	160-FRK2	160-CMA1
	2.2	3	160-BMA2	1321-3R12-A	160-LFA2	160-RFB-14-A	160-FRK2	160-CMA1
	4.0	5	160-BMA2 ❹	1321-3R18-A	—	160-RFA-22-B	160-FRK3	160-CMA1
380-460VAC 50/60 Hz 3-Phase	0.37	1/2	—	1321-3R2-B	160-LFB1	160-RFB-5-A	—	160-CMB1
	0.55	3/4	—	1321-3R2-A	160-LFB1	160-RFB-5-A	—	160-CMB1
	0.75	1	160-BMB1	1321-3R2-A	160-LFB1	160-RFB-5-A	160-FRK2	160-CMB1
	1.5	2	160-BMB2	1321-3R4-B	160-LFB1	160-RFB-5-A	160-FRK2	160-CMB1
	2.2	3	160-BMB2	1321-3R8-B	160-LFB1	160-RFB-14-A	160-FRK2	160-CMB1
4.0	5	160-BMB2 ❹	1321-3R18-B	—	160-RFB-14-B	160-FRK3	160-CMB1	
Ready/Fault Panel Catalog No. 160-B1	Program Keypad Module Catalog No. 160-P1			DeviceNet Communication Module Catalog No. 160-DN2 ❷	RS-232 Communication Module Catalog No. 160-RS1 ❷		24V DC Interface ❸ Catalog No. 160-DM-SF1 (Analog) 160-DM-PS1 (Preset)	
Remote Programming Adapter Catalog No. 160-RPA ❹	Remote Keypad Module Catalog No. 160-P2 ❹			CopyCat Keypad Module Catalog No. 160-P3 ❹	Cable Catalog No. 160-C10 (1 meter, non-locking each end) 160-C10R (1 meter, non-locking each end, right angle) 160-C30 (3 meter, locking each end) 160-C50 (5 meter, locking each end)			

- ❶ Bulletin 160 Series C drives (with proper filter) meet:
 - Overall EMC requirements of EN61800-3 for Second (Industrial) Environments
 - High frequency conducted and radiated emissions of EN61800-3 for (First) Residential Environments
 - High frequency conducted and radiated emissions of EN55011 for (Second) Industrial Environments
- ❷ The MTBF for the fan is 40,000 hours at 50°C.
- ❸ Catalog numbers listed are for 3% impedance open style units. NEMA Type 1 and 5% impedance reactor types are also available. Refer to publication 1321-2.0 for detailed information.
- ❹ 160-LF type filters have been tested with a maximum motor cable length of 75 meters (250 feet) for 230V units and 40 meters (133 feet) for 460V units.
- ❺ 160-RF type filters have been tested with a maximum motor cable length of 25 meters (80 feet) for both 230V and 460V units. Listed filters are for Bulletin 160 Series C drives only.
- ❻ Two in parallel required.
- ❼ Compatible with Bulletin 160 Series A, Series B and Series C drives with firmware version FRN 4.07 or later.
- ❽ Allows 24VDC sinking inputs. Bulletin 160 Series C drives must use a Series B, or later, 24V DC Interface module.
- ❾ Compatible with Bulletin 160 Series C drives with firmware version FRN 7.03 or later.

Accessory Dimensions

All dimensions are in millimeters and (inches). Dimensions are not used for manufacturing purposes.

Dynamic Brake Modules

Figure B.1

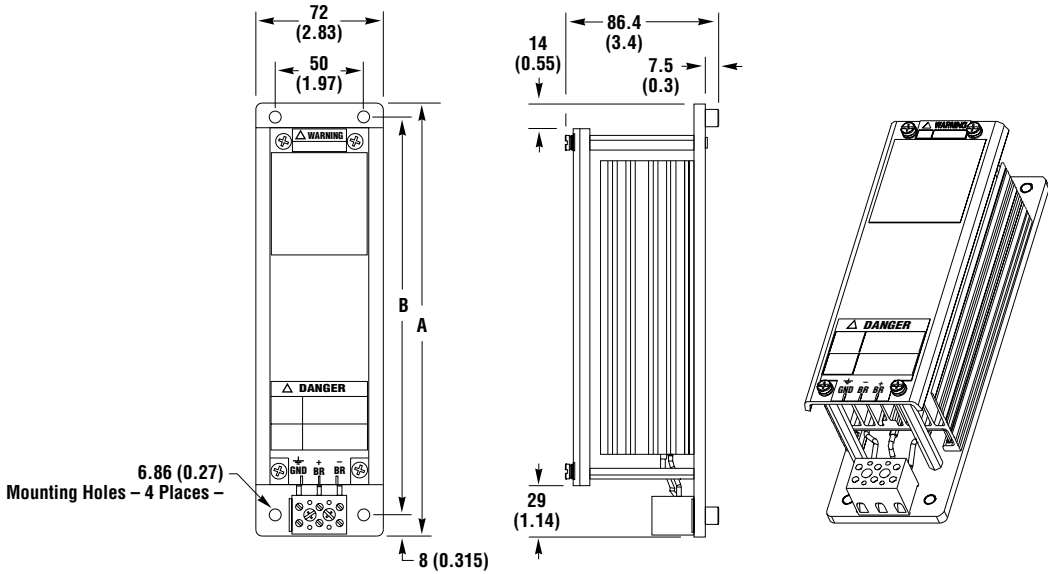

Catalog No.	A	B
160-BMA1 & 160-BMB1	245 (9.64)	225 (8.86)
160-BMA2 & 160-BMB2	334 (13.15)	314 (12.36)

Bulletin 1321 Line Reactors

Figure B.2

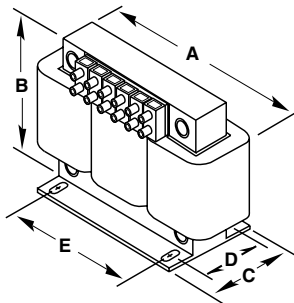

Catalog No.	A	B	C	D	E
1321-3R2-A	112 (4.4)	104 (4.1)	74 (2.9)	50 (2.0)	37 (1.44)
1321-3R2-B	112 (4.4)	104 (4.1)	74 (2.9)	50 (2.0)	37 (1.44)
1321-3R4-A	112 (4.4)	104 (4.1)	76 (3.0)	50 (2.0)	37 (1.44)
1321-3R4-B	112 (4.4)	104 (4.1)	76 (3.0)	50 (2.0)	37 (1.44)
1321-3R8-A	152 (6.0)	127 (5.0)	76 (3.0)	53 (2.1)	51 (2.0)
1321-3R8-B	152 (6.0)	127 (5.0)	76 (3.0)	53 (2.1)	51 (2.0)
1321-3R12-A	152 (6.0)	127 (5.0)	76 (3.0)	53 (2.1)	51 (2.0)
1321-3R18-A	152 (6.0)	133 (5.3)	79 (3.1)	51 (2.0)	51 (2.0)

Accessory Dimensions, Continued

All dimensions are in millimeters and (inches). Dimensions are not used for manufacturing purposes.

Line Filters

Figure B.3

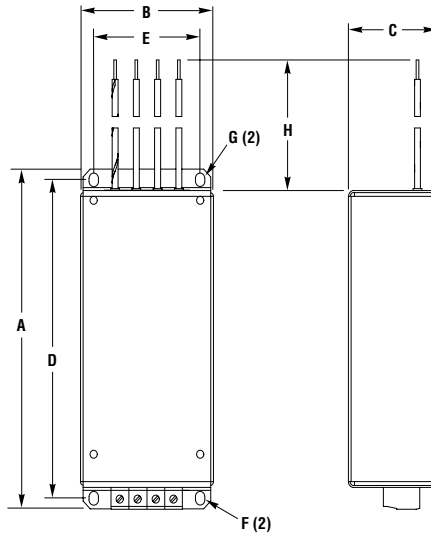

Line Filter Module	A	B	C	D	E	F	G	H
160S-RFA-9-A	182.0	75.0	37.5	163.0	60.0	M4.5 x 6.5 (0.18 x 0.26) obround hole (2 places)	M4.5 x 6.5 (0.18 x 0.26) obround hole (2 places)	200 (7.87)
160-RFB-5-A	(7.17)	(2.95)	(1.47)	(6.42)	(2.36)			
160-RFB-14-A	182.0	75.0	47.5	163.0	60.0	M4.5 (0.18) slot (2 places)	M4.5 (0.18) (2 places)	
160S-RFA-16-B	227.0	87.0	55.5	212.0	60.0			
160-RFA-22-B	(8.94)	(3.43)	(2.18)	(8.35)	(2.36)			
160-RFB-14-B								
160 LF (All Types)	174.0	75.0	50.0	163.0	60.0	7.0 x 5.3 (0.28 x 0.21) hole dim.	6.9 x 5.25 (0.272 x 0.207) hole dim.	
	(6.85)	(2.95)	(1.97)	(6.42)	(2.36)			

Accessory Dimensions, Continued

All dimensions are in millimeters and (inches). Dimensions are not used for manufacturing purposes.

Capacitor Module

Figure B.4

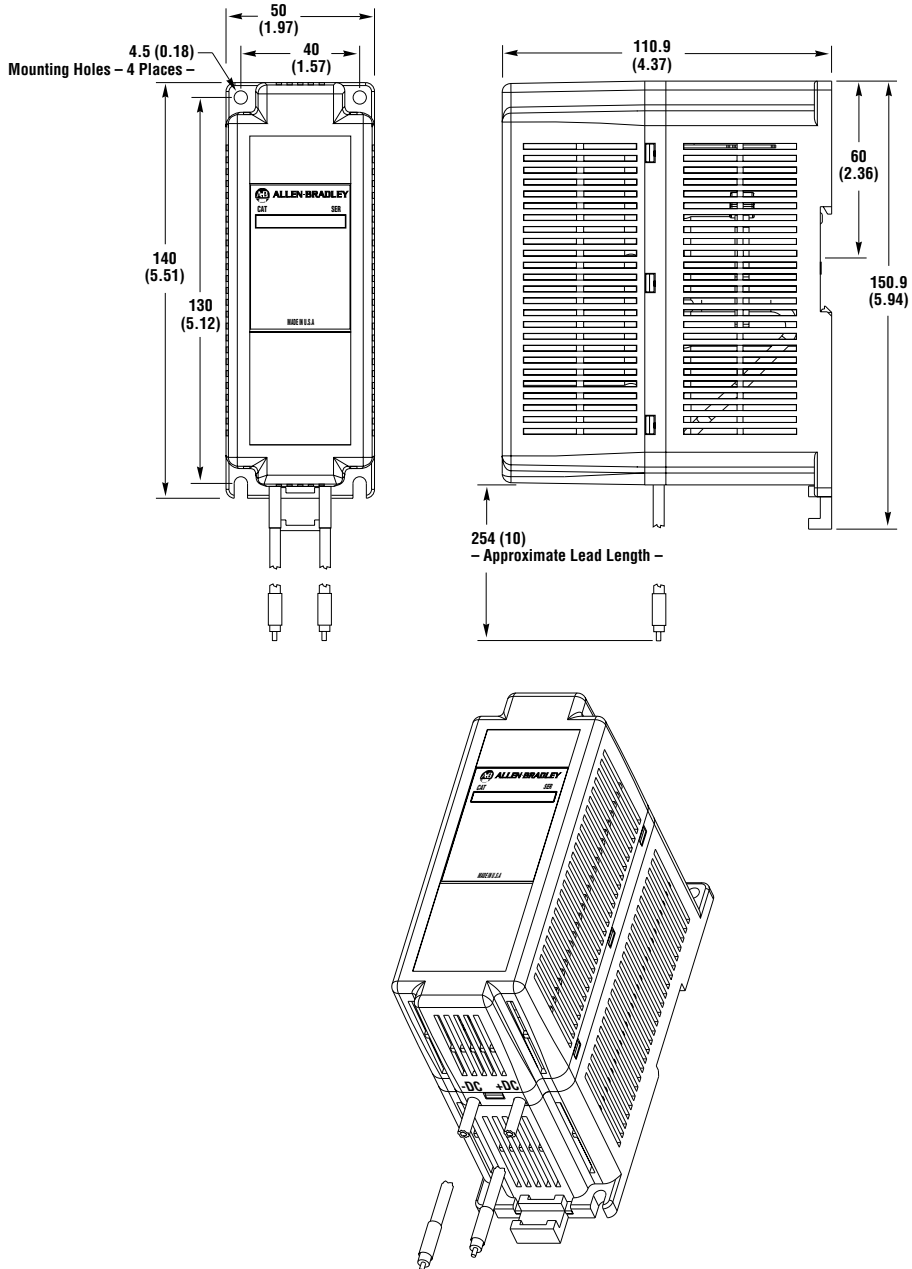

Accessory Dimensions, Continued

All dimensions are in millimeters and (inches). Dimensions are not used for manufacturing purposes.

DeviceNet or RS-232 Module Attached to Drive (DeviceNet Shown)

Figure B.5

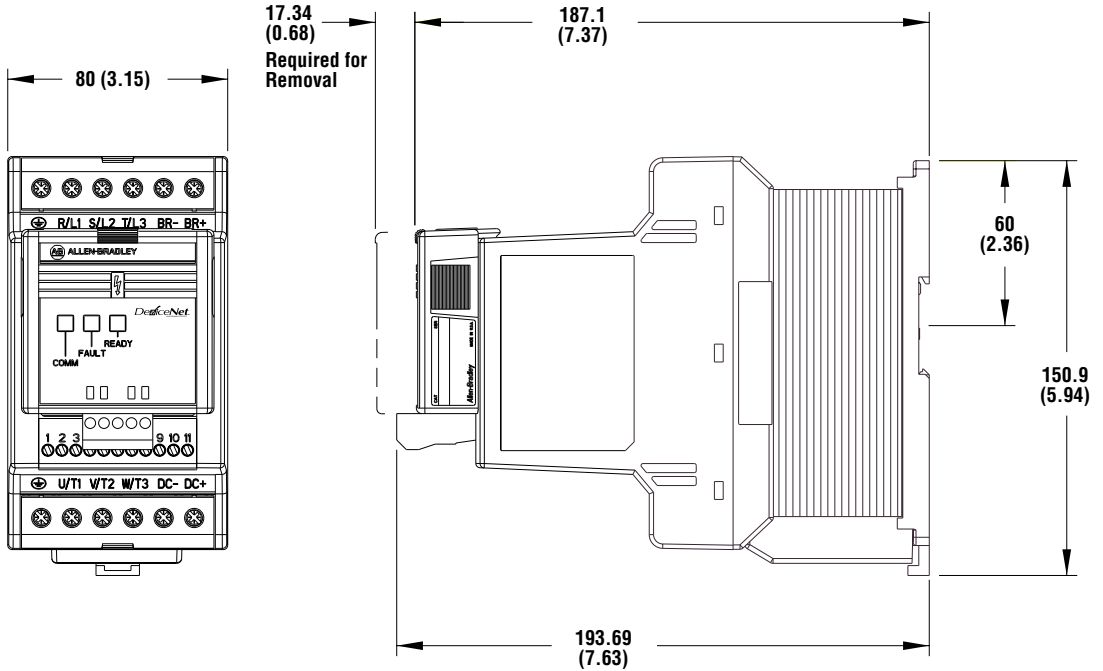

24V DC Interface Module

Figure B.6

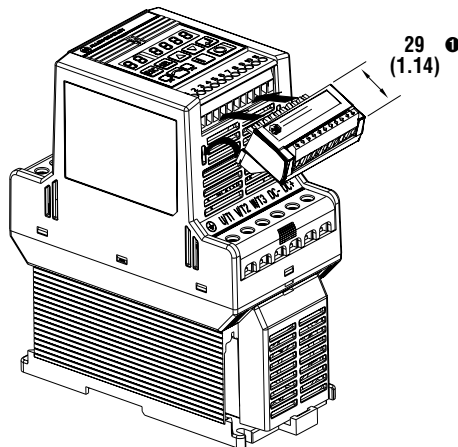

❶ This device does not effect the overall height of the drive.

Drive Dimensions

All dimensions are in millimeters and (inches), all weights are in kilograms and (pounds).

Reference Diagram A

Figure B.7

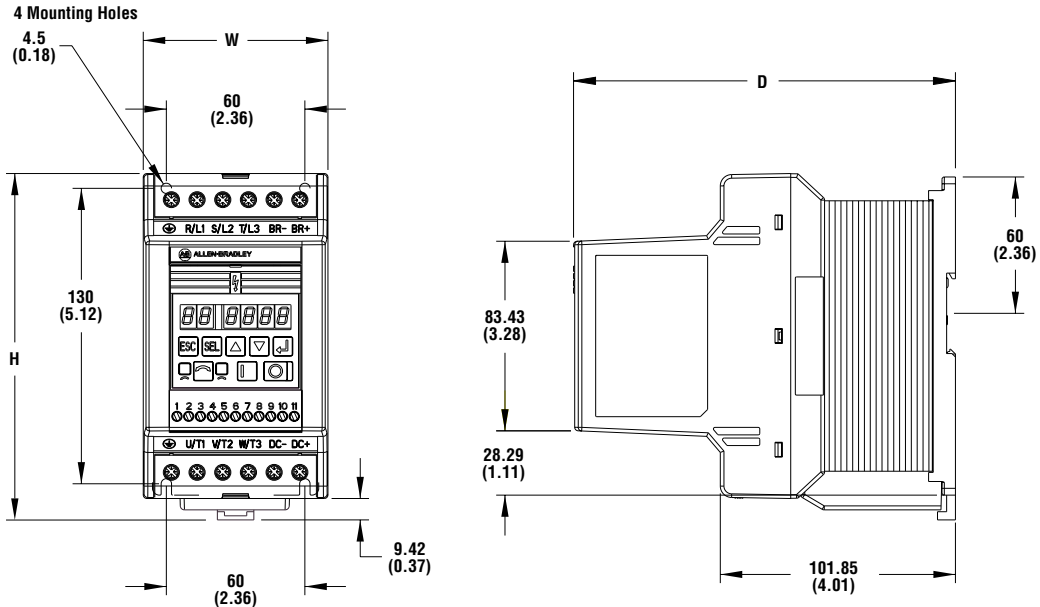

Drive Dimensions and Weights

Table B.4

200-240VAC — 1-Phase				
Drive	H	W	D	Weight
160S-AA02	152 (6.00)	80 (3.15)	165 (6.51)	0.94 (2.07)
160S-AA03	152 (6.00)	80 (3.15)	165 (6.51)	0.94 (2.07)
160S-AA04	152 (6.00)	80 (3.15)	165 (6.51)	1.02 (2.24)
200-240VAC — 3-Phase				
Drive	H	W	D	Weight
160-AA02	152 (6.00)	80 (3.15)	165 (6.51)	0.94 (2.07)
160-AA03	152 (6.00)	80 (3.15)	165 (6.51)	0.94 (2.07)
160-AA04	152 (6.00)	80 (3.15)	165 (6.51)	1.02 (2.24)
160-AA08	152 (6.00)	80 (3.15)	165 (6.51)	1.02 (2.24)
160-AA12	152 (6.00)	80 (3.15)	165 (6.51)	1.10 (2.43)
380-460VAC — 3-Phase				
Drive	H	W	D	Weight
160-BA01	152 (6.00)	80 (3.15)	165 (6.51)	0.94 (2.07)
160-BA02	152 (6.00)	80 (3.15)	165 (6.51)	0.94 (2.07)
160-BA03	152 (6.00)	80 (3.15)	165 (6.51)	1.02 (2.24)
160-BA04	152 (6.00)	80 (3.15)	165 (6.51)	1.02 (2.24)
160-BA06	152 (6.00)	80 (3.15)	165 (6.51)	1.10 (2.43)

Important: Use Figure B.10: *Drilling Template A* for mounting a drive listed in the table above.

All dimensions are millimeters and (inches), all weights are kilograms and (pounds).

Reference Diagram B

Figure B.8

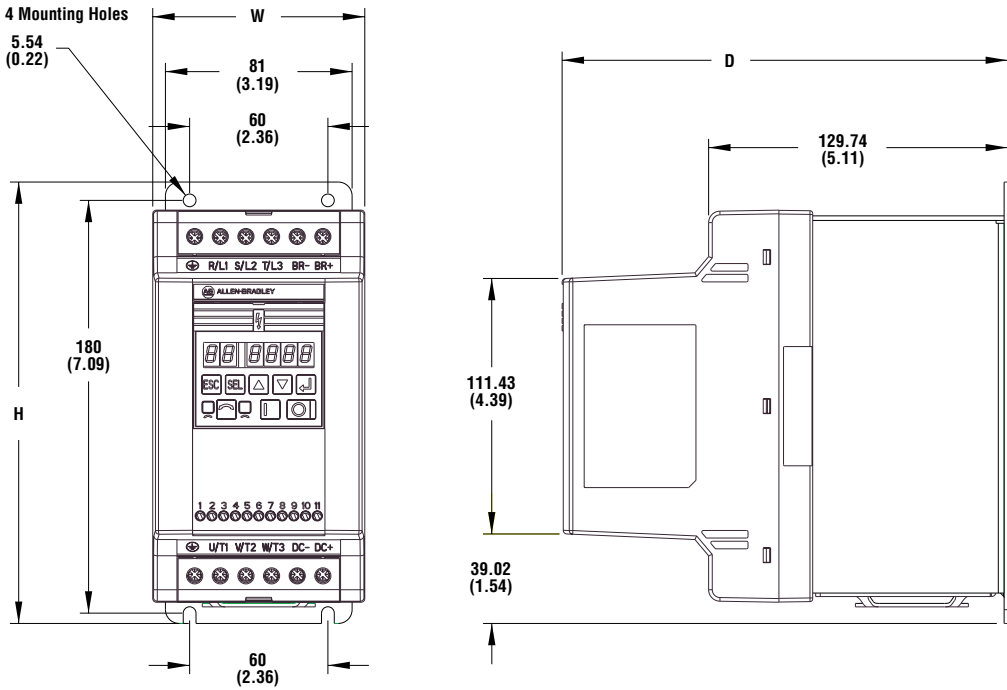

Drive Dimensions and Weights

Table B.5

200-240VAC — 1-Phase				
Drive	H	W	D	Weight
160S-AA08	193 (7.58)	92 (3.62)	193 (7.61)	2.37 (5.23)
200-240VAC — 3-Phase				
Drive	H	W	D	Weight
160-AA18	193 (7.58)	92 (3.62)	193 (7.61)	2.37 (5.23)
380-460VAC — 3-Phase				
Drive	H	W	D	Weight
160-BA10	193 (7.58)	92 (3.62)	193 (7.61)	2.37 (5.23)

Important: Use Figure B.11: *Drilling Template B* for mounting a drive listed in the table above.

Drive Mounting Hole Dimensions

Figure B.9

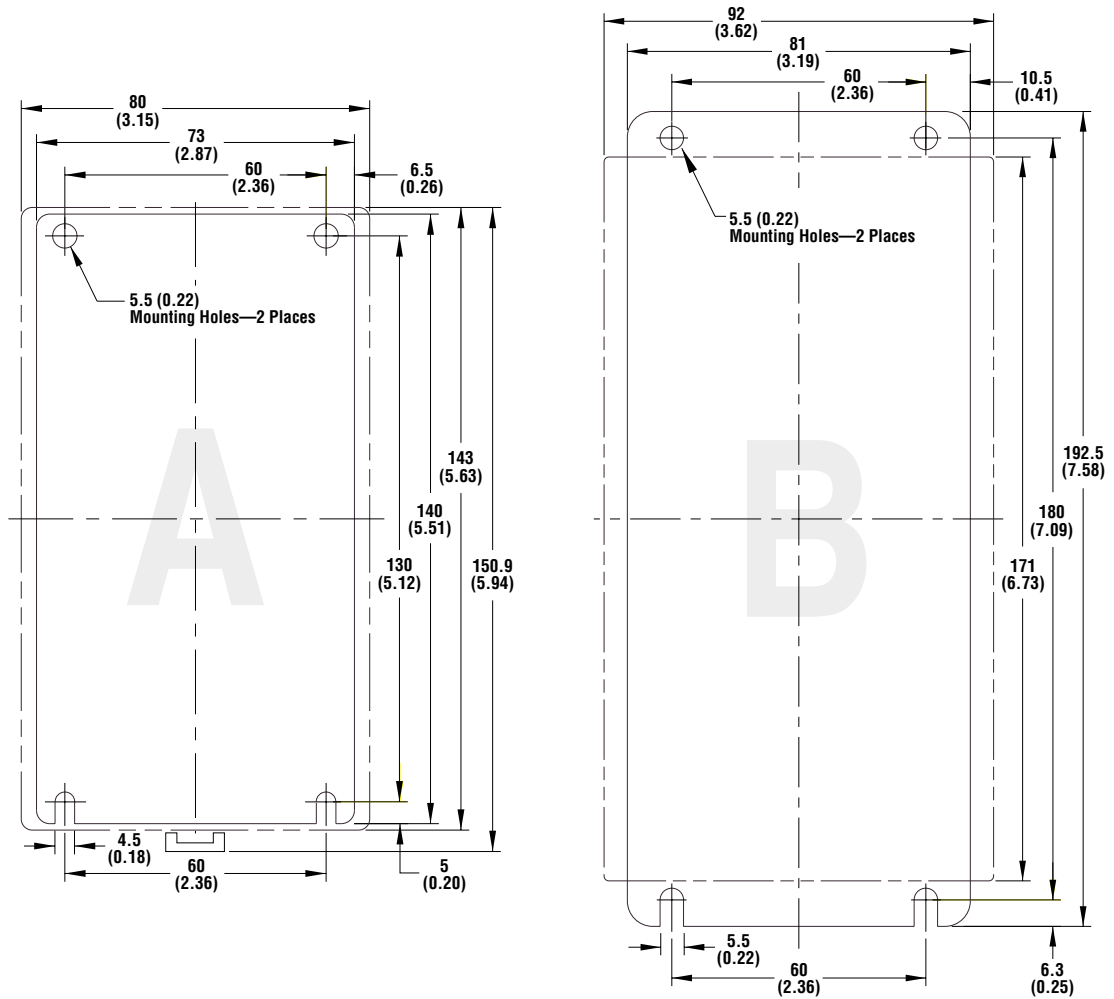

This illustration depicts the mounting hole placements for the drives listed below. Use the appropriate Drilling Template for your drive.

200-240V AC — 1-Phase	
160S-AA02	A
160S-AA03	A
160S-AA04	A
160S-AA08	B

200-240V AC — 3-Phase	
160-AA02	A
160-AA03	A
160-AA04	A
160-AA08	A
160-AA12	A
160-AA18	B

380-460V AC — 3-Phase	
160-BA01	A
160-BA02	A
160-BA03	A
160-BA04	A
160-BA06	A
160-AA10	B

Drilling Template A

Figure B.10

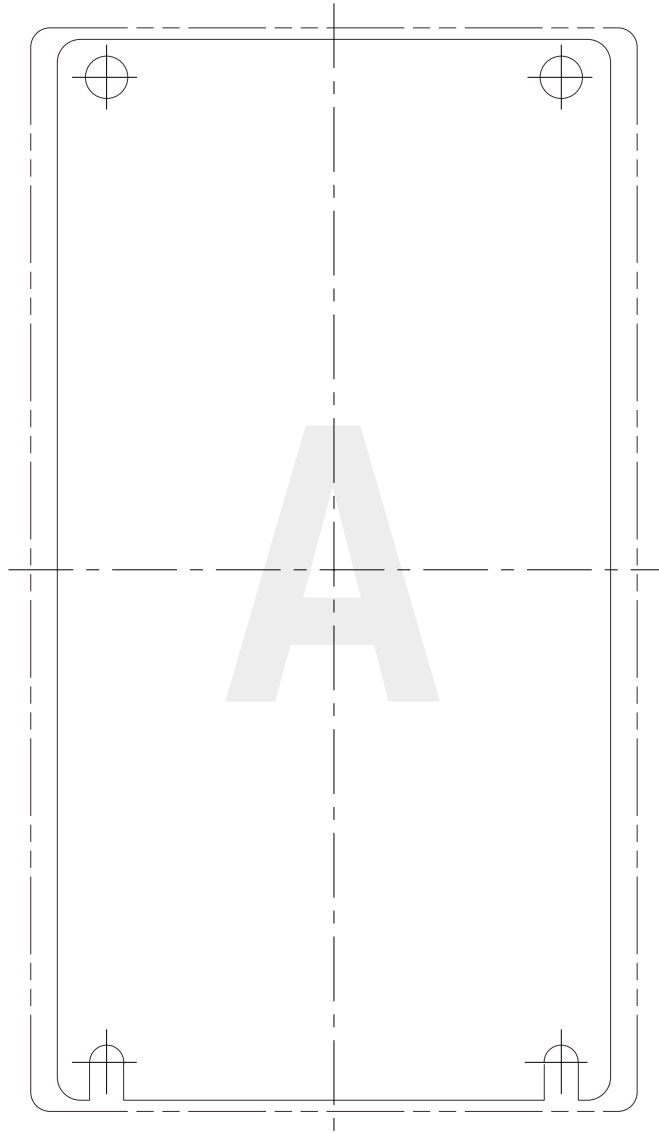

Drilling Template B

Figure B.11

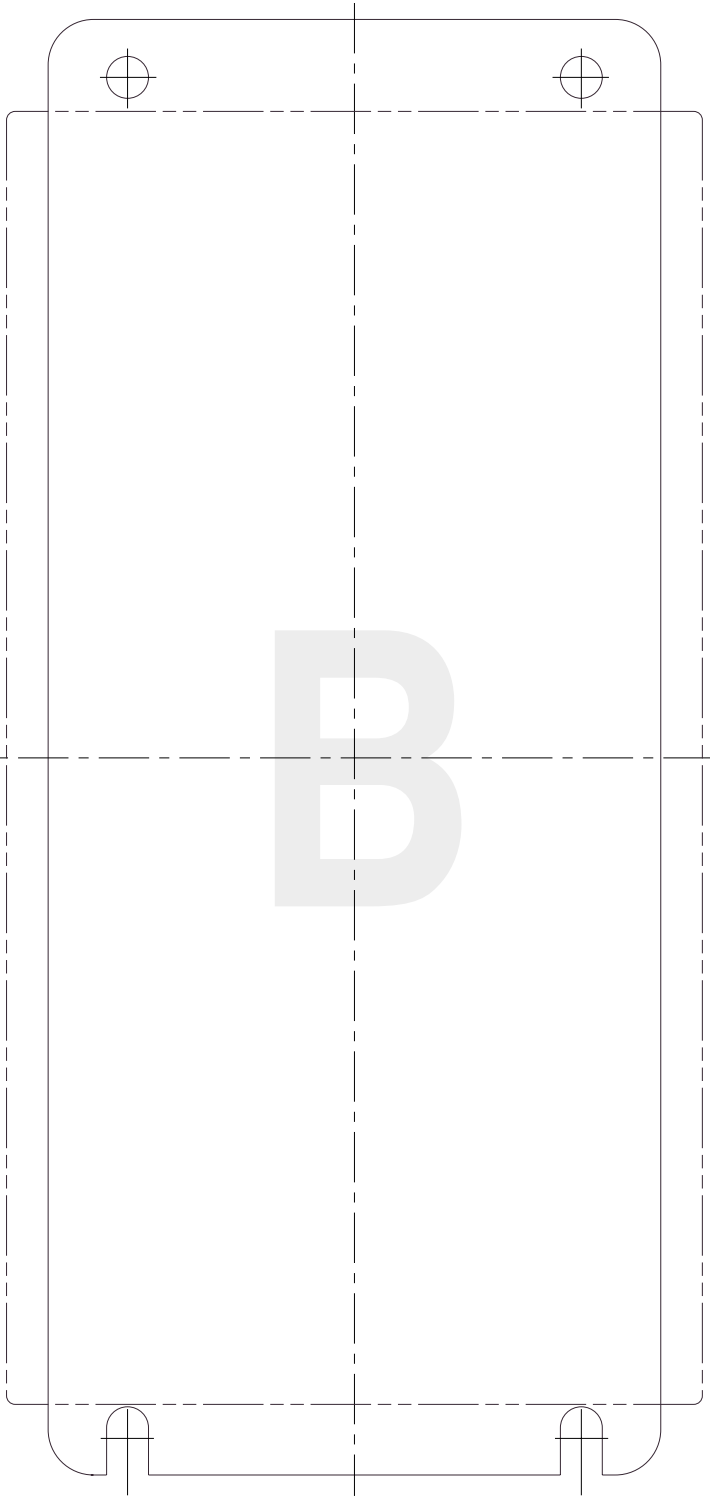

CE Conformity

CE Compliance

This drive is a component intended for implementation in machines or systems for the industrial environment. It is CE marked for conformity to the Low Voltage (LV) Directive 73/23/EEC when installed as described. It also has been tested to meet the Council Directive 89/336 Electromagnetic Compatibility (EMC). The standards used for this testing are, LV: EN50178, EN60204-1, EMC EN61800-3, EN50081-1, EN50082-2. These tests were conducted with a PWM frequency (Parameter 49) of 4.0 kHz.

Important: The conformity of the drive and filter to any standard does not guarantee that the entire installation will conform. Many other factors can influence the total installation and only direct measurements can verify total conformity. It is therefore the responsibility of the machine manufacturer, to ensure, that the conformity is met.

A copy of the Declaration of Conformity (DOC) is available from your local Rockwell Automation Sales Office.

Essential Requirements for a Conforming EMC Installation

The following seven items are required for CE Conformance:

1. An input line filter module (see Appendix B, *Accessories and Dimensions*) must be installed to reduce conducted emissions.

160-LF Filters

These units have been tested with a maximum motor cable length of 75 meters (250 feet) for drives rated 200 – 240V AC, and 40 meters (133 feet) for drives rated 380 – 460V AC.

160S-RF Filters

These units have been tested with a maximum motor cable length of 25 meters (80 feet) for both 230V and 460V units.

2. The drive system must be mounted in a shielded enclosure to reduce radiated emissions.
3. Grounding of equipment and cable shields must be solid, with low impedance connections.
4. Motor and control cables entering the shielded enclosure must have EMC-tested shielded cable clamps, or grounded metal conduit.
5. All motor cables must use shielded cable, or be in grounded metal conduit.
6. All control and signal wiring must use shielded cable or be in grounded metal conduit.
7. The Common terminals (TB3-3 and 7) must have a solid connection to ground terminal/protective earth.

General Instructions for an EMC Compliant Installation

Shielded Enclosure

- Typical NEMA or IEC metal enclosures are adequate.
- The ground connection of the shielded enclosure must be solidly connected to the PE terminal of the drive. Good conductivity must be assured – grounding must provide a low impedance path for high frequency signals.
- All wiring, except input power leads, must use shielded cable.
- Input power, output power and control wiring inside the enclosure must be physically separated.
- Input power, output power and control wiring outside the enclosure must use separate shielded cables, or separate conduit.
- Wires do not touch the heatsink.

Recommended Grounding Configuration

Figure C.1

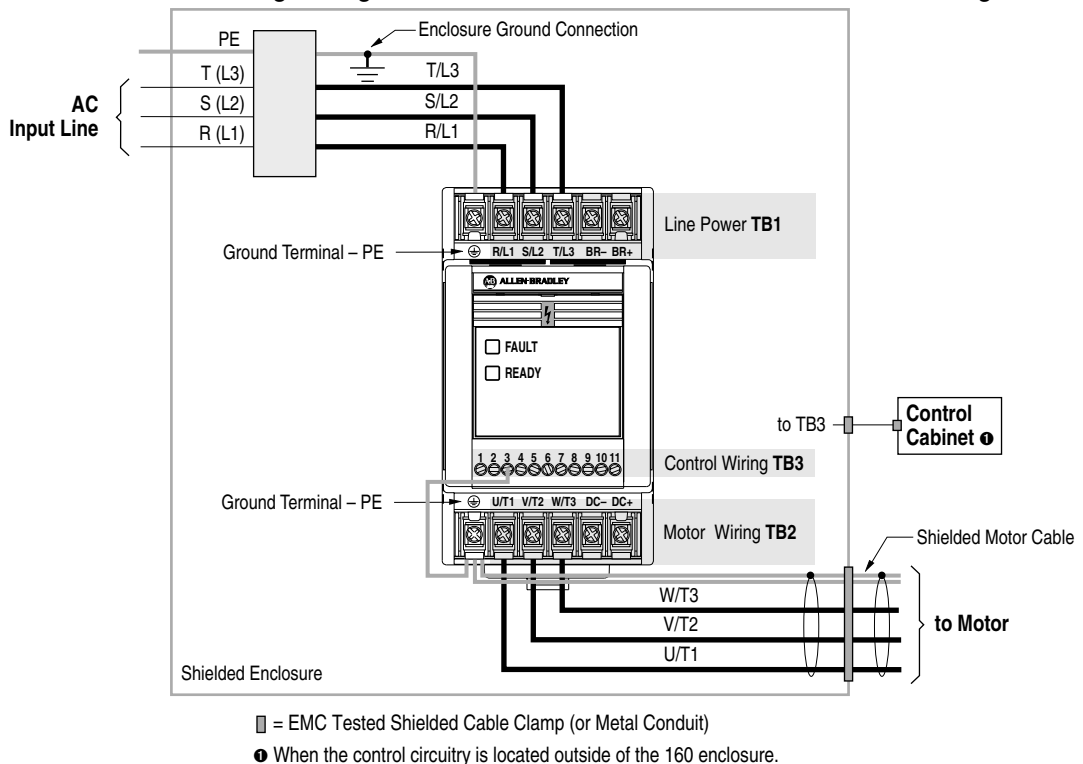

Cable Clamps

- Use suitable EMC-tested cable clamps only.
- The connection area must be 360 degrees around the shielded cable.
- The cable clamps also provide strain-relief for the cable.
- When using conduit, the contact point of metal entry connections must be free of paint or non-conductive surfaces and solidly connected with good conductivity to the enclosure.

Motor Cable

- The cable between the drive and motor must be a 4-wire shielded cable (three phases and ground).
- Do not exceed the maximum motor cable length for the specific line filter module used.
- Inside the shielded enclosure, shielded motor cable must be used as close to the drive's output terminals as possible. The shield must be solidly connected to the PE terminal of the drive.
- Where the shielded motor cable exits the enclosure, an EMC-tested cable clamp, or metal conduit must be used to solidly connect the cable shield to the enclosure.
- The shield on the motor side must be solidly connected to the motor housing with an EMC-tested cable clamp, or conduit, providing good conductivity from the cable shield to the motor housing.

Motor Connections

Figure C.2

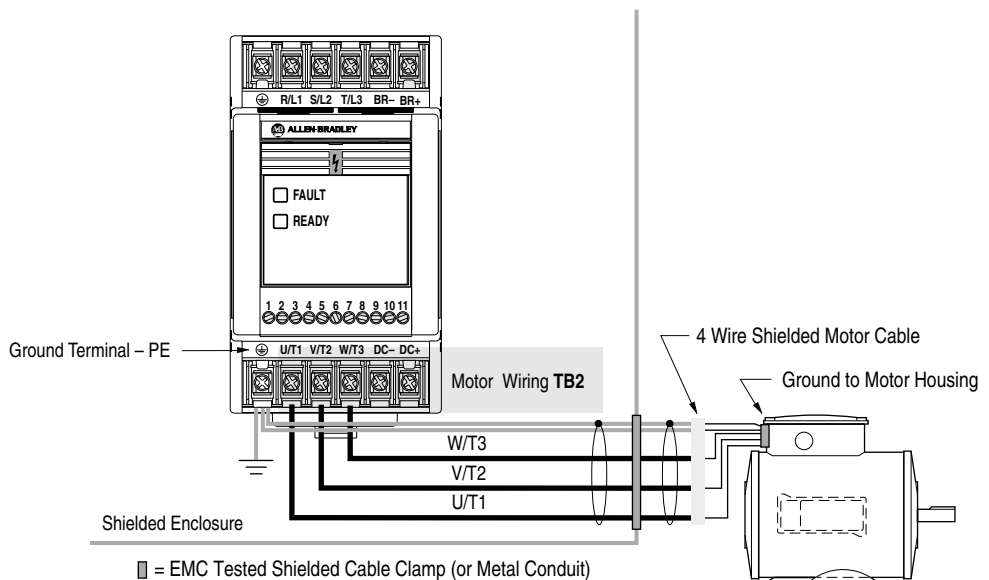

Control Cable

- Control wiring must use shielded cable, or grounded metal conduit.

Shielded Motor and Control Cable Example

Figure C.3

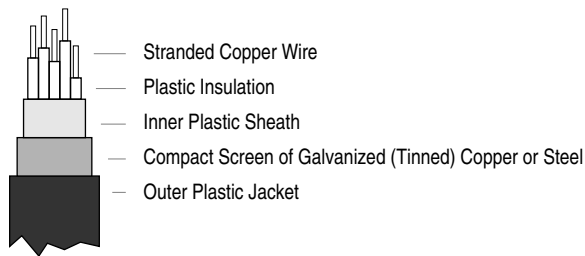

- The shield must be connected to signal common at both ends of the cable.
- The Common terminals (TB3-3 & 7) must be solidly connected (and as short as possible) to the PE terminal of the drive.

Control Connections

Figure C.4

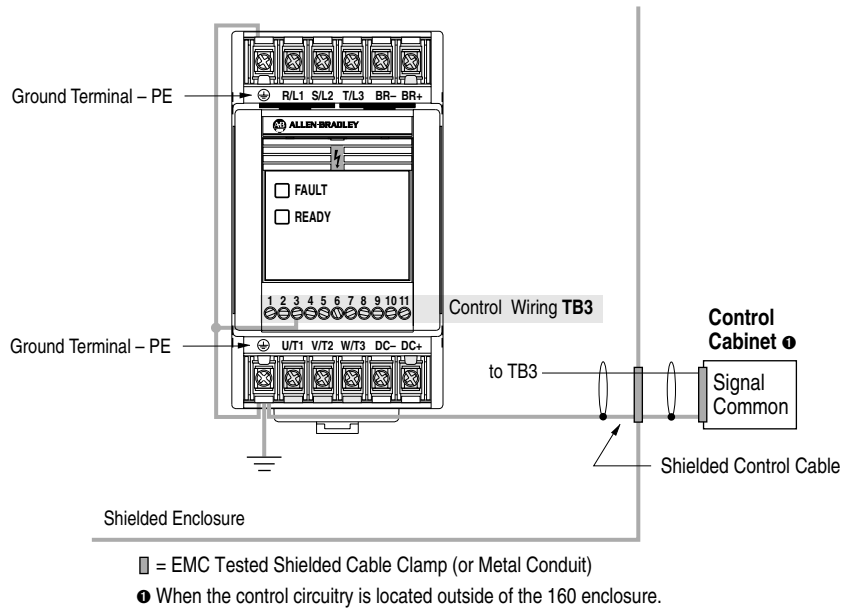

Low Voltage Directive 73/23/EEC Compliance

This product complies with Low Voltage Directive 72/23/EEC when conforming with the following installation requirements:

- Review Chapter 1, *Important Precautions* and other **ATTENTION** statements throughout this manual prior to installation of the drive.
- The drive is intended to be installed with a fixed connection to the earth. The use of residual-current-operated protective devices (RCDs) or ground fault indicators is not recommended. If unavoidable, the Bulletin 160 is compatible with type B RCDs only.
- The drive should be installed in an appropriate or suitable enclosure.

Important: The conformity of this drive and filter to any standard does not guarantee that the entire installation will conform. Many factors can influence the total installation and only direct measurements can verify total conformity.

End of Chapter

Symbols

±10V DC control 2-19

Numerics

12V internal power supply 2-9

24V DC interface module B-5

4 – 20 mA control 2-19

A

AC input wiring 2-3

Accel/Decel control 5-5, 5-13

accessories (see optional accessories) B-1

ambient temperature 2-1, A-2

analog input

frequency sources 2-18

analog inversion

inverting input 5-15

analog scaling

analog input min/max 5-15

analog select 5-14

zero offset 5-12

analog signal 2-18

approvals

CE A-2, C-1

CSA A-2

CUL A-2

arrow keys 3-2

auto restart 5-10

B

block diagram 6-4

braking

DC injection 5-8

enabling dynamic braking 5-11

stop mode 5-6

branch circuit disconnect 2-3

branch circuit protection 2-5

C

capacitive current cable length recommendations
2-8

capacitor module B-1, B-4

connection 1-5

carrier frequency A-3

PWM 5-10

catalog number

explanation 1-2

location 1-3

CE 2-1, A-2, C-1

change direction (see also analog inversion) 3-2

circuit breaker ratings 2-5

clearing faults 5-12, 6-1

compensation 5-15

compliance

CE A-2, C-1

CSA A-2

CUL A-2

EEC C-5

conditioning input power 2-6

control wiring 2-9–2-17

precautions 2-9

preset speed 2-20

requirements 2-9

CSA A-2

CUL A-2

current limiting 5-8

D

DeviceNet module 1-5, B-5

diagnostics

display group parameters 5-3–5-5

fault descriptions 6-2

dimensions

24V DC interface module B-5

capacitor module B-4

DeviceNet module B-5

drive B-6, B-7

dynamic brake module B-2

line filter module B-3

line reactor B-2

mounting B-8

direction indicators 3-2

display mode 3-1

dynamic brake module B-1, B-2

connection 1-5

dynamic braking 5-11

E

electrostatic discharge 1-1, 3-3

enter key 3-2

escape key 3-2

F

fan replacement B-1

faults

clearing 5-12, 6-1

descriptions 6-2

problems and corrective actions 6-3

status LEDs 1-4

- features
 - optional 1-5
 - standard 1-4
- frequency control
 - min/max frequency 5-6
 - skip frequency 5-7
- frequency source 2-18
- fuse ratings 2-5

G

- grounding 2-3, 2-9

I

- input mode selection 2-11, 5-9
- input power
 - conditioning 2-6
 - protection 2-5
- installation
 - clearances 2-1
 - EMC compliance C-1–C-4
 - templates B-9, B-10
- internal 12V power supply 2-9

K

- keypad
 - display mode 3-1
 - installation 3-4
 - key descriptions 3-2
 - program mode 3-1
 - removal 3-3

L

- LEDs 1-4, 3-2
- line filter module 1-5, B-1, B-3
- line reactor B-1, B-2
- line side protection 2-5
- lock protection 5-12

M

- motor cable
 - length recommendations 2-7–2-8
 - long cable effects 2-7
 - recommended cable 2-6
 - reflective wave 2-7
- motor starter 2-5
- mounting requirements
 - clearances 2-1
- mounting templates B-9, B-10

N

- nameplate information 1-3

O

- optional accessories
 - 24V DC interface module 1-5, B-5
 - capacitor module 1-5, B-4
 - DeviceNet module 1-5, B-5
 - dynamic brake module 1-5, B-2
 - line filters 1-5, B-1, B-3
 - line reactors B-1, B-2
 - program keypad module 1-5
- output contacts 2-9, 5-10
- overload protection 2-5, 5-8

P

- parameters 5-1–5-16
 - commonly changed 5-1
 - display group 5-3–5-5
 - 01 - [Output Frequency] 5-3
 - 02 - [Output Voltage] 5-3
 - 03 - [Output Current] 5-3
 - 04 - [Output Power] 5-3
 - 05 - [Bus Voltage] 5-3
 - 06 - [Frequency Command] 5-3
 - 07 - [Last Fault] 5-3
 - 08 - [Heatsink Temperature] 5-3
 - 09 - [Controller Status] 5-3
 - 10 - [Controller Type] 5-3
 - 11 - [Control Version] 5-3
 - 12 - [Input Status] 5-4
 - 13 - [Power Factor Angle] 5-4
 - 14 - [Memory Probe Display] 5-4
 - 15 - [Preset Status] 5-4
 - 16 - [Analog Input] 5-4
 - 17 - [Fault Buffer 0] 5-5
 - 18 - [Fault Buffer 1] 5-5
 - 19 - [Fault Buffer 2] 5-5
 - overview 5-1
 - program group 5-5–5-16
 - 30 - [Accel Time 1] 5-5
 - 31 - [Decel Time 1] 5-6
 - 32 - [Maximum Frequency] 5-6
 - 32 - [Minimum Frequency] 5-6
 - 34 - [Stop Mode Select] 5-6
 - 35 - [Base Frequency] 5-6
 - 36 - [Base Voltage] 5-6
 - 37 - [Boost Select] 5-7
 - 37 - [Maximum Voltage] 5-6
 - 39 - [Skip Frequency] 5-7

- 40 - [Skip Frequency Band] 5-7
 - 41 - [Motor Overload Select] 5-8
 - 42 - [Motor Overload Current] 5-8
 - 43 - [Current Limit] 5-8
 - 44 - [DC Hold Time] 5-8
 - 45 - [DC Hold Voltage] 5-9
 - 46 - [Input Mode] 5-9
 - 47 - [Output Configure] 5-10
 - 48 - [Output Threshold] 5-10
 - 49 - [PWM Frequency] 5-10
 - 50 - [Restart Tries] 5-10
 - 51 - [Restart Time] 5-11
 - 52 - [DB Enable] 5-11
 - 53 - [S-Curve] 5-11
 - 54 - [Clear Fault] 5-12
 - 55 - [Memory Probe Address] 5-12
 - 56 - [Reset Functions] 5-12
 - 57 - [Program Lock] 5-12
 - 58 - [Internal Frequency] 5-12
 - 59 - [Frequency Select] 5-12
 - 60 - [Zero Offset] 5-12
 - 61 – 68 - [Preset Frequency 0-7] 5-13
 - 69 - [Accel Time 2] 5-13
 - 70 - [Decel Time 2] 5-13
 - 71 - [IR Compensation] 5-14
 - 72 - [Slip Compensation] 5-14
 - 73 - [Reverse Disable] 5-14
 - 74 - [Analog Select] 5-14
 - 75 - [Analog Input Minimum] 5-15
 - 76 - [Analog Input Maximum] 5-15
 - 78 - [Compensation] 5-15
 - 79 - [Software Current Trip] 5-15
 - 80 - [Stall Fault Time] 5-15
 - 81 - [PI Proportional Gain] 5-16
 - 82 - [PI Integral Gain] 5-16
 - 83 - [PI Process Reference] 5-16
 - resetting to factory defaults 5-12
 - potentiometer wiring 2-19
 - power wiring 2-2
 - precautions 2-2
 - terminal block specifications 2-3
 - precautions 1-1
 - preset frequencies 5-12
 - Program Keypad Module 1-5
 - display mode 3-1
 - installation 3-4
 - key descriptions 3-2
 - program mode 3-1
 - removal 3-3
 - program lock 5-12
 - program mode 3-1
 - programming 5-1
 - example 5-2
 - reset to defaults 5-2
- R**
- reflected wave protection 2-7
 - reflective wave
 - cable length 2-7
 - RWR (reflective wave reducer) 2-7
 - resetting default values 5-12
 - reverse key 3-2
 - RS-232 module B-5
- S**
- S-Curve 5-11
 - select key 3-2
 - specifications A-1–A-3
 - 380-460V AC input ratings A-1
 - control 2-9
 - electrical 2-2
 - environment 2-1
 - input power protection 2-5
 - installation 2-1
 - wiring 2-3
 - start key 3-2
 - start-up 4-1
 - stop key 3-2
 - storage temperature 2-1, A-2
- T**
- terminal block
 - control wiring 2-9
 - specifications 2-9
 - TB1 2-2
 - TB2 2-2
 - TB3 2-2
 - troubleshooting 6-1
 - fault descriptions 6-2
 - problems and corrective actions 6-3
- V**
- vibration A-2

W

wiring

analog input 2-18

cable length 2-7

control/signal 2-9–2-17

motor cable specifications 2-6

symbol key 2-10

terminal block specifications 2-3

Reach us now at www.rockwellautomation.com

Wherever you need us, Rockwell Automation brings together leading brands in industrial automation including Allen-Bradley controls, Reliance Electric power transmission products, Dodge mechanical power transmission components, and Rockwell Software. Rockwell Automation's unique, flexible approach to helping customers achieve a competitive advantage is supported by thousands of authorized partners, distributors and system integrators around the world.



Americas Headquarters, 1201 South Second Street, Milwaukee, WI 53204, USA, Tel: (1) 414 382-2000, Fax: (1) 414 382-4444
European Headquarters SA/NV, avenue Herrmann Debroux, 46, 1160 Brussels, Belgium, Tel: (32) 2 663 06 00, Fax: (32) 2 663 06 40
Asia Pacific Headquarters, 27/F Citicorp Centre, 18 Whitfield Road, Causeway Bay, Hong Kong, Tel: (852) 2887 4788, Fax: (852) 2508 1846

**Rockwell
Automation**